

ProMill 8000 Milling Center

USER'S GUIDE



Catalog # 200066 Rev C

intelitek ®

Copyright © Intelitek Inc.

Tel: (603) 625-8600

ProMill 8000 Milling Center User's Guide

Fax: (603) 437-2137

Catalog #200066 Rev C

August 2016

website: <http://www.intelitek.com>

email: info@intelitek.com

All rights reserved. No part of this publication may be stored in a retrieval system, or reproduced in any way, including but not limited to photocopy, photography, magnetic or other recording, without the prior agreement and written permission of the publisher. Program listings may be entered, stored and executed in a computer system, but not reproduced for publication.

Every effort has been made to make this book as complete and accurate as possible. However, no warranty of suitability, purpose, or fitness is made or implied. Intelitek is not liable or responsible to any person or entity for loss or damage in connection with or stemming from the use of the software, hardware and/or the information contained in this publication.

Intelitek bears no responsibility for errors that may appear in this publication and retains the right to make changes to the software, hardware and manual without prior notice.

Warnings

The operation of rotating machinery should only be attempted by experienced, knowledgeable individuals.

Read the entire contents of this guide before running the ProMill 8000 Milling Center.

To avoid possible injury always observe the safety precautions described in this User's Guide.

The following icons indicate important information throughout this User's Guide.



Safety

Provides essential safety instructions that must be followed to prevent operator injury or death.



Product Care

Provides recommendations for reducing the chance of machine damage.



Take Note

Provides important information about your product.

Table of Contents

Using this Guide	iv
1. Safety Guidelines	1
1.1. Detailed Safety Guidelines.....	1
1.2. Safety Checklist	5
2. Introducing the ProMill 8000	6
2.1. Overview of Standard Features	6
2.2. ProMill 8000 Components.....	8
2.3. Overview of CNCBase/Motion Control Software	12
2.4. Standard Accessories.....	12
2.5. Optional Accessories	13
3. Installing the Hardware and Software	14
3.1. Preparing for Installation.....	14
3.2. Installing the Hardware	18
3.3. Installing the Software.....	20
3.4. Contacting Technical Support.....	33
3.5. Returning Defective Products.....	33
4. Maintaining the ProMill 8000	35
4.1. Cleaning the Milling Center	35
4.2. Maintaining Individual Milling Machine Components.....	36
4.3. Maintenance Schedule Summary	38
4.4. Adjusting and Maintaining the Pneumatic Systems	39
4.5. Maintaining the PC in a Shop Environment.....	41
5. Using the Control Software.....	42
5.1. Launching the Control Software.....	42
5.2. Selecting Online or Simulation Mode	44
5.3. Software Interface.....	45
5.4. Homing	61
5.5. Opening an NC File	62
5.6. Verifying an NC Program	64
5.7. Running an NC Program	71
5.8. Accessing Help	72
6. Installing a Tool	73

6.1.	Removing the Tool Holder from the Spindle	74
6.2.	Inserting the Tool into the Tool Holder	74
6.3.	Inserting the Tool Holder into the Spindle	75
7.	Tutorial: Milling a Sample Part.....	77
7.1.	Reviewing Safety Procedures	78
7.2.	Preparing Tools and Materials.....	78
7.3.	Opening the Sample NC File	78
7.4.	Determining the Stock Size.....	79
7.5.	Configuring the Verify Settings.....	80
7.6.	Defining the Tool	84
7.7.	Verifying the Program	86
7.8.	Turning On and Homing the Machine	87
7.9.	Mounting the Workpiece	88
7.10.	Setting the Axes Zero Positions	88
7.11.	Performing a Dry Run	93
7.12.	Running the Program.....	94
8.	Basic CNC Programming.....	96
8.1.	Elements of an NC Part Program	96
8.2.	General Programming Suggestions	97
8.3.	Reviewing an NC Program	98
8.4.	NC Codes	98
9.	NC Programming Routines.....	129
9.1.	Linear Interpolation Programming	129
9.2.	Circular Interpolation Programming in the XY Plane	130
9.3.	Circular Interpolation Programming in Other Planes	132
9.4.	Rapid Traverse Programming	133
9.5.	Helical Interpolation Programming	134
9.6.	Canned Cycle Programming	135
9.7.	Subprogram Programming	143
10.	Multiple Tool Programming	145
10.1.	Specifying the Tools.....	146
10.2.	Configuring the ATC.....	146
10.3.	Writing an NC Program for Multiple Tools	147
10.4.	Establishing the Reference Tool	148
10.5.	Setting Tool Offsets	149
10.6.	Testing the Multi-tool Program	152

10.7.	Tutorial: Running a Multi-tool Program	153
11.	An Introduction to CNC Milling	158
11.1.	Understanding Coordinate Systems	158
11.2.	Setting Spindle Speeds	161
11.3.	Setting Feed Rate and Depth of Cut	162
11.4.	Selecting Lubricants and Coolants	163
11.5.	Tool Types	163
11.6.	Sharpening the Tools	165
12.	Automation Integration	166
12.1.	Integration Instructions	166
12.2.	CNC Programming for Robotic Communication	169
12.3.	Sample Robot - CNC Communication Sequence	171
12.4.	Sample Robotic - CNC Integration Programs	179

Using this Guide

Welcome to the ProMill 8000 User's Guide.

This guide is designed to help you install and begin using the ProMill 8000 hardware and software. The later chapters provide an NC programming reference.

We recommend that you use the guide as follows.

1. Read chapter 1 Safety Guidelines. Review this chapter often.
2. Read chapter 2 Introducing the ProMill 8000.
3. Install the hardware and software as described in chapter 3 Installing the Hardware and Software.
4. Read chapter 4 Maintaining the ProMill 8000.
5. Read chapter 5 Using the Control Software.
6. Read chapter 6 Installing a Tool
7. Follow the instructions in the tutorial presented in chapter 7 Tutorial: Milling a Sample Part.
8. Use the remaining chapters as a reference guide for NC programming.
 - a. Chapter 8 Basic CNC Programming presents guidelines for writing basic NC programs, and lists and describes the use of all codes available for use with the ProMill 8000.
 - b. Chapter 9 NC Programming Routines provides instructions with examples for advanced NC programming routines.
 - c. Chapter 10 Multiple Tool Programming provides instructions for configuring the control software and writing NC code for programs that require the use of more than one cutting tool. The chapter also presents step-by-step instructions for milling a sample part using multiple tools.
 - d. Chapter 11 An Introduction to CNC Milling provides a basic introduction to the theory of CNC milling.
 - e. Chapter 12 Automation Integration provides instructions for integrating the ProMill 8000 in a robotic environment.

1. Safety Guidelines

The safety rules presented here should be reviewed and practiced by all operators of the ProMill 8000 milling center.

This section presents the following information:

Section Contents: Safety Guidelines		
Section	Name	Page
1.1	Detailed Safety Guidelines	1
1.2	Safety Checklist	5

1.1. DETAILED SAFETY GUIDELINES

The table below provides detailed safety instructions.

Info Table: Safety Guidelines		
Category	Guideline	Comment
Operator knowledge and authorization	Review the User's Guide.	Read this guide carefully before you use the milling center and keep it readily accessible for quick reference. Know the intended applications and limitations of the milling center as well as its hazards.
	Keep untrained visitors away from the equipment.	Children and visitors unfamiliar with the hazards of rotating machinery should always be kept away from the work area.
Behavior	Do not overreach.	Keep your footing and balance at all times so you won't fall against or clutch at the moving machine.
	Do not operate the machine under the influence of alcohol or drugs.	Alcohol or drugs may impair your judgment and reaction time, which could contribute to an on-the-job accident.
	Avoid distractions while running the machine.	Use simple common sense and pay attention while operating any piece of machinery.

Work Area	Keep the work area clean.	Cluttered work areas and bench tops invite accidents.
	Avoid a dangerous environment.	Don't use the milling center in damp or wet locations. Never operate electrical equipment in the presence of volatile and flammable petroleum-based solvents and lubricants.
	Keep coolant away from electrical components.	Do not allow coolant to splash into or near the computer.
Clothing and Hair	Avoid loose hair and clothing.	Don't wear loose clothing or jewelry that can get caught in moving parts. Wear a hat or hair net, or tie your hair back to keep it away from moving parts.
Safety Equipment	Wear safety glasses.	During operation any power tool can throw foreign objects and harmful chemicals into your eyes. Always put on safety glasses or eye shields before starting up the milling center. Safety glasses or shields should provide full protection at the sides, as well as the front of the eyes.
	Ground all tools.	The milling center has an AC power cord terminated by a three-prong plug. The power cord should be plugged into a three-hole, grounded receptacle. If a grounding adapter is used to accommodate a two-prong receptacle, the adapter wire must be attached to a known ground. Never remove the third prong from the plug on the AC power cord.
	Keep the safety door closed while machine is in motion.	The safety door should remain in place whenever the spindle motor is on or the cross slide is moving.
	Remove adjusting keys and wrenches.	Make it a habit to check that keys and adjusting wrenches are removed from the milling center before using the machine.
Emergency Stop	Stopping the machine.	<p>Before you run the ProMill 8000 for the first time, you should know how to stop the machine should an emergency situation arise.</p> <p>To initiate an emergency stop on the milling center, either:</p> <ul style="list-style-type: none"> • Press the Emergency Stop button, or • Turn the machine off at the power switch. <p>In non-emergency situations, the machine can be stopped in the following ways:</p> <ul style="list-style-type: none"> • Simultaneously press the Control and Space Bar keys on the computer keyboard • Activate one of the limit switches • Activate the safety door interlock switch.
	When to use the Emergency Stop.	You should use the Emergency Stop button to disconnect power to the milling center when faced with a problem such as a tool breaking or a collision occurring, and while performing routing operations, such as when changing tools or mounting or removing a workpiece.

	Using the machine-mounted emergency stop button.	There is an Emergency Stop button located on the front panel of the milling center; it has an oversized red cap. To engage: Press the button in. To release: Turn the button clockwise, it will pop out on its own.
	Using the software stop button.	The execution of the part program can be interrupted by pressing the Control and Spacebar buttons on the computer keyboard. Unlike using the Emergency Stop button, this method of stopping the milling center does not cause the software to lose track of the tool position.
Operation Rules	General	Proper setup of the milling center is essential for safe milling. These procedures must be followed each time a new tool is mounted. General setup requirements for the milling center include checking components for cleanliness and lubrication, mounting the cutting tool, mounting the workpiece, and setting the spindle rotation speed.
	Avoid accidental starting.	Make sure the power switch is off before plugging in the milling center power cord.
	Check milling machine components.	Always examine the machine to be sure that the work area is free of shavings and particles from previous operations. Remove such debris from the milling machine to avoid possible binding of components which may result in possible damage to the milling machine, the workpiece, or the operator. Always make sure the machine is properly lubricated.
	Do not force a tool.	Select the feed rate and depth of cut that are best suited to the design, construction, and purpose of the cutting tool. It is always better to take too light a cut than too heavy a cut.
	Use the right tool.	Select the type of cutting tool best suited to the milling operation. Don't force a tool or attachment to do a job it wasn't designed for.
	Maintain cutting tools in good condition.	Keep cutting tools sharp and clean. Lubricate and clean milling center components on a regular basis.
	Mount the cutting tool correctly.	Each cutting tool used in the milling operation must be sharp and properly installed in the spindle. The cutting edge of the tool must be on the centerline or just below the centerline (0.004 inch or 0.1 mm maximum) of the axis of rotation of the milling machine
	Secure the workpiece.	Be certain that the workpiece is firmly clamped to the table or secured in a vice.
	Tighten all holding, locking and driving devices.	Tighten the work holders and tool holders. Do not over tighten these devices. Over tightening may damage threads or warp parts, thereby reducing accuracy and effectiveness.
	Turn the spindle by hand before starting.	Manually turning the spindle allows you to safely determine that the tool will not hit the milling center bed, cross slide, or stock on start up.

	Set the spindle rotation speed.	The ProMill Milling Center is equipped with an electronically controlled spindle motor which produces a comprehensive range of spindle rotation speeds. Speed can be set with the Control Software or by using an S code in the NC program. Always use a safe spindle speed.
Accessories	Use recommended accessories only.	To avoid stressing the milling center and creating a hazardous milling environment, use only those accessories designed for use with the ProMill 8000, available through Intelitek Corporation.

1.2. SAFETY CHECKLIST



Post copies of this checklist in the work area. Verify that all items are checked-off prior to each operation of the ProMill milling center.

Before you enter the work area:

- Put on safety glasses.
- Tie back loose hair and clothing.
- Remove jewelry including rings, bracelets and wristwatches.

Before milling a part:

- Make sure you have the correct tool for the job.
- Secure the tool properly.
- Make sure all tool positions have been properly initialized.
- Verify the NC program on the computer.
- Remove all loose parts and pieces from the machine.
- Remove adjusting keys and wrenches from the machine.
- Close the safety door.
- Only operate the machine after being properly trained in its use.
- Perform a dry run:
 - Make certain there is no workpiece in place.
 - Run the NC program to make sure all the moves make sense before running the program with a workpiece in place.
- After completing the dry run, properly secure the workpiece to the machine.
- Keep fluids away from all electrical connections, electronic or electrical devices, the computer, and nearby electrical outlets.

While milling a part:

- Do not touch moving or rotating parts.
- Press the Emergency Stop button before opening the safety door.
- Only open the safety door after the spindle has stopped rotating.
- Press the Emergency Stop button whenever changing tools or mounting or removing a workpiece.
- Release the Emergency Stop button only after closing the safety door.
- Keep all unauthorized persons away from the work area.

2. Introducing the ProMill 8000

The ProMill 8000 is a versatile PC-based CNC milling center that enables you to deliver robust instruction in computer numerical control and advanced manufacturing.

The ProMill 8000 comes equipped with 3-axis stepper motors, ball screws, a variable speed A/C powered brushless spindle motor, limit/home switches, and an ISO 20 taper spindle with a 10 mm maximum tool diameter and 150 mm throat.

This CNC system requires no assembly and is ready to run on an Ethernet port on a standard PC, and fits comfortably into any classroom without sacrificing features.

Like larger industrial machines, the ProMill 8000 uses EIA, ISO, and Fanuc-compatible G&M code programs to cut parts in a variety of materials.

This section presents the following information:

Section Contents: Introducing the ProMill 8000		
Section	Name	Page
2.1	Overview of Standard Features.	6
2.2	ProMill 8000 Components	8
2.3	Overview of CNCBase/Motion Control Software.	12
2.4	Standard Accessories	12
2.5	Optional Accessories	13

2.1. OVERVIEW OF STANDARD FEATURES

Some of the ProMill Milling Center's most notable hardware and software features are listed in the table below:

Info Table: Standard Features	
Network and software features	Ethernet-based control
	PC-based CNC software
	EIA RS-274D standard G&M code programming
	A built-in full-screen NC program editor with graphic tool path verification
	Multiple tool programming
	Help functions on screen
Standard hardware features	4th axis ready
	Brushless spindle motor
	Pneumatic drawbar

Standard milling specifications	y-axis travel of 6 inches (152 mm)
	X-axis travel of 10.24 inches (260mm)
	Z-axis travel of 7.09 inches (180mm)
	Feed rates up to 20 IPM (500mm/min) (rapid traverse up to 79 IPM (2000mm/min))
	Computer-controlled spindle speeds from 100 to 5,000 RPM
Safety features	Full enclosure with automatic safety door lock
	Automatic diagnostics and power cut off protection
	Safety door and limit switches
	Emergency stops from the milling center and computer keyboard
Machine ready optional accessories	Coolant ready
	Jog pendant ready
	Robotic integration ready with 6 inputs, 6 outputs

2.2. PROMILL 8000 COMPONENTS

This section shows the location of major components of the ProMill 8000, arranged by the view from which they are visible:

Section Contents: Components



2.2.1 External View, pg. 9



2.2.2 Right Side Panel, pg. 10

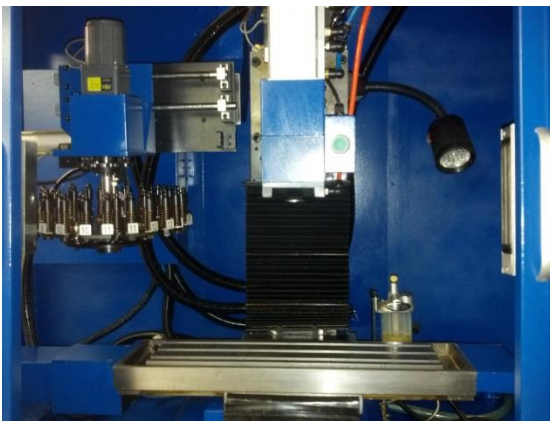

2.2.3 Enclosure , pg. 11



2.2.4 Rear Pneumatics Panel, pg. 12

2.2.1. External View

The external view is shown below.

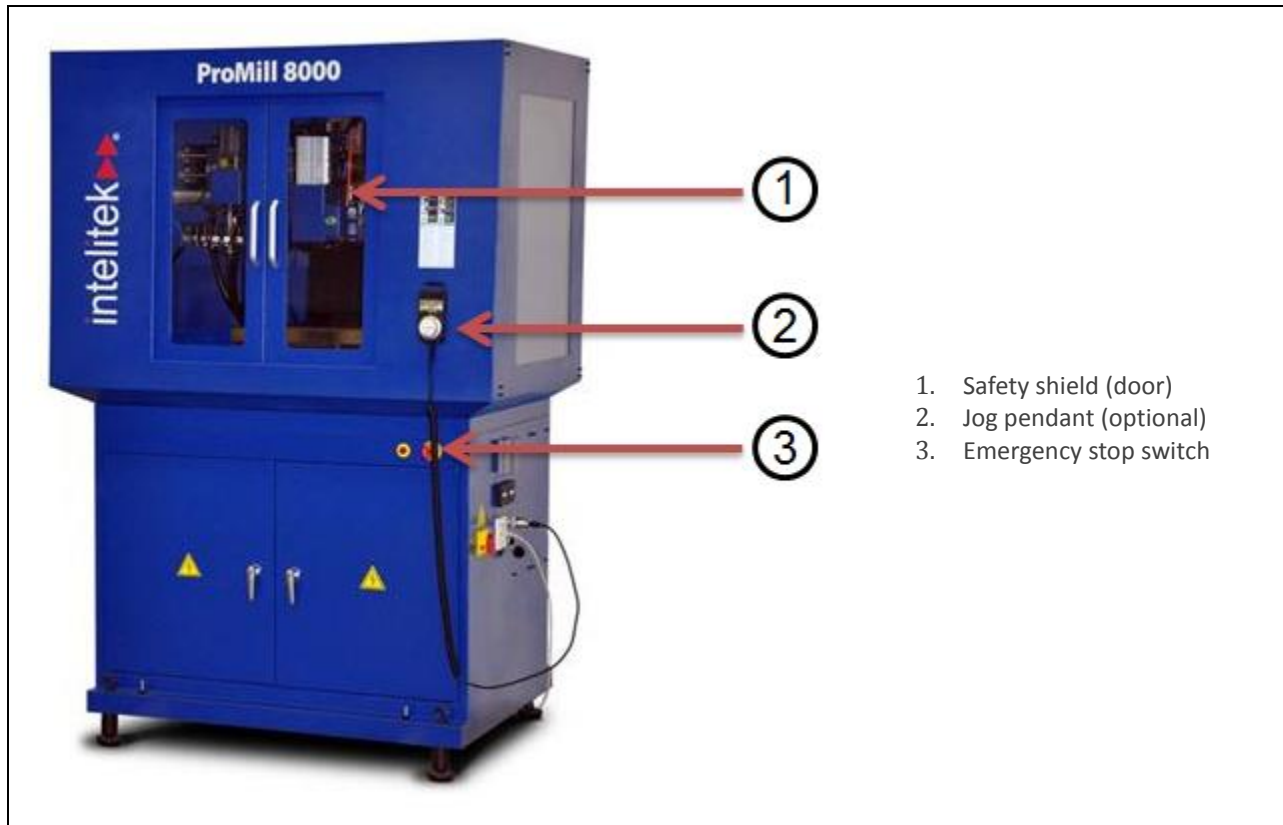

Notes:

- The Safety door encloses the milling area to help protect the operator from flying chips. A magnetic shield interlock switch prevents the machine from operating with the shield open.
- The Emergency Stop button is used to halt machine operation. When pushed, machine operation stops immediately. To resume operation, the button must be rotated clockwise and will then pop out on its own. It is important that this button be pushed in (i.e. engaged) before performing any manual operation, such as changing the stock or tooling.

2.2.2. Right Side Panel

The graphic below shows the machine as viewed from the right side.

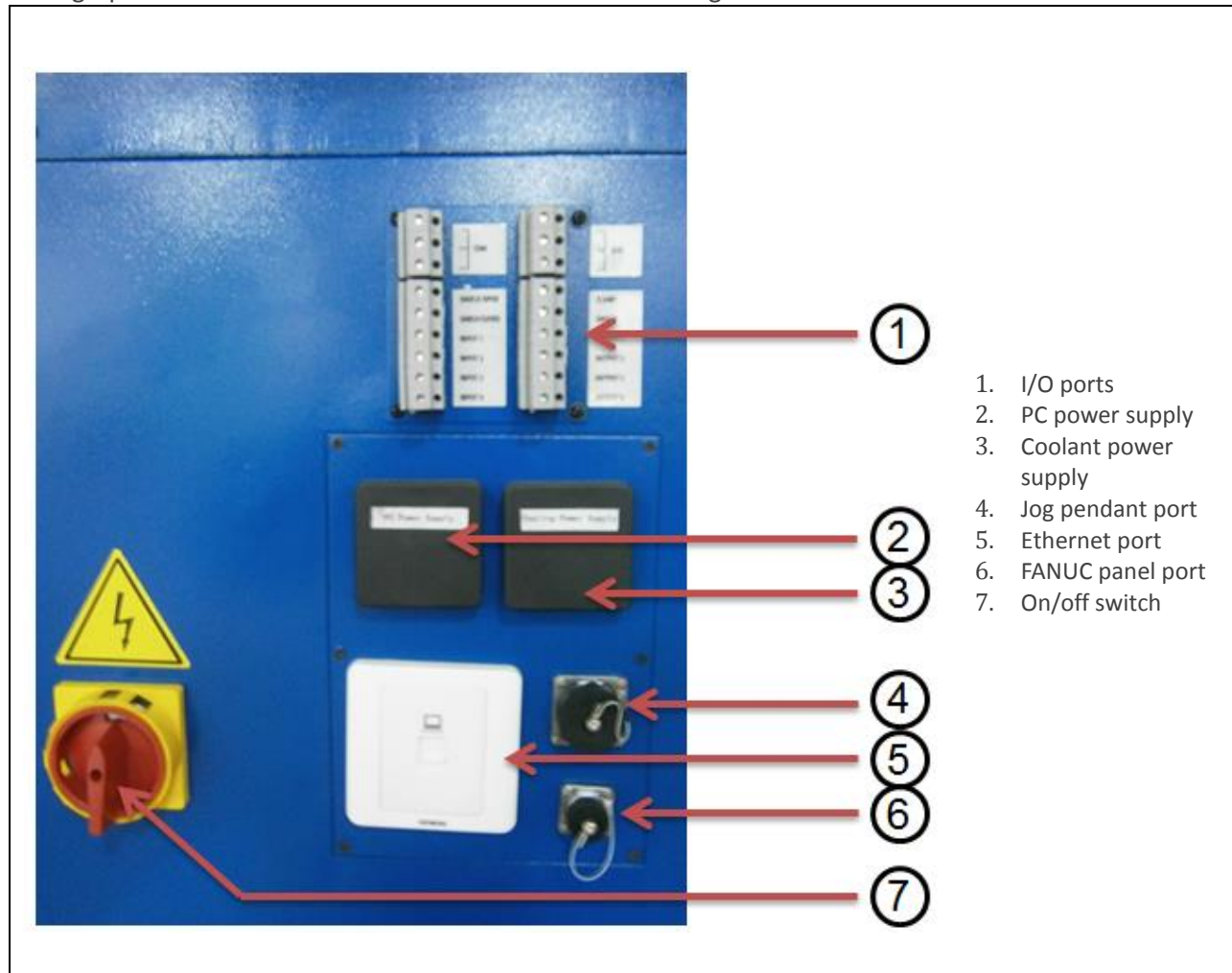

2.2.3. Enclosure

The graphic below shows the contents exposed by opening the safety shield.

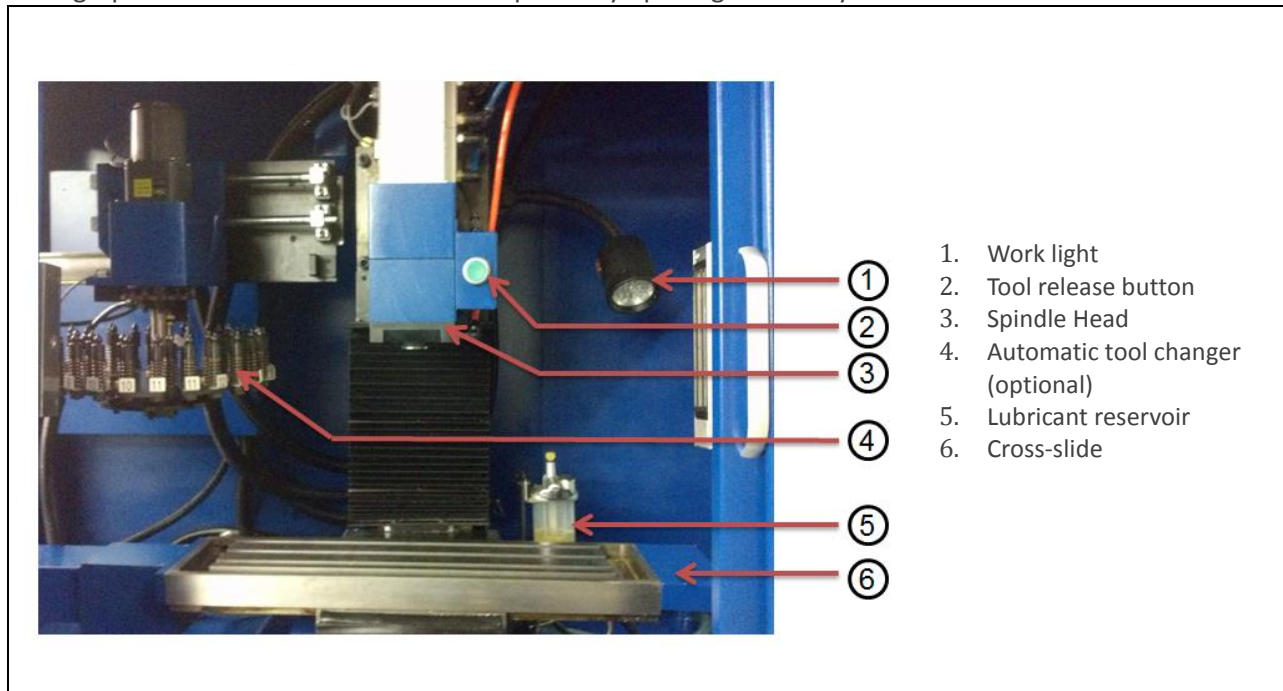

2.2.4. Rear Pneumatics Panel

The pneumatic controls for the 12 station tool changer (optional) and drawbar air-blast are located in the rear pneumatics panel. For more information, see 4.4 Adjusting and Maintaining the Pneumatic Systems, pg. 39.



2.3. OVERVIEW OF CNCBASE/MOTION CONTROL SOFTWARE

The heart of the ProMill 8000 milling center is the control software (CNCMotion or CNCBase) that runs on your computer. Using industry standard EIA RS- 274D NC codes, the control software provides for two-axis CNC programming and milling.

The control software is extremely easy to use with all necessary functions readily available to run a part program.

CNCBase and CNCMotion differ only in that CNCMotion provides 3D simulation of the milling procedure.

2.4. STANDARD ACCESSORIES

The accessory kit supplied with the milling center contains all the tools and hardware necessary for installing and maintaining the milling center. Additional tool holding devices and tools are available as options.

This table below lists the standard accessories supplied with the ProMill 8000.

Info Table: Standard Accessories		
One shot lubrication system		
Internal work light		
Milling center accessory package:		
		
Item	Qty	Description
1	1	ISO 20 Tool holder
2	1	ER 16 Collet - 4mm diameter
3	1	3mm End mill 3mm shank
4	1	1/8" End mill 1/8" shank
5	1	Tool holder wrench - 30mm
6	1	5mm x 20mm Fuse
7	1	Allen wrenches, set of 6
8	1	CNCBase control software
9	1	Open-ended wrenches, set of 3
10	1	Tool holder nut wrench
11	2	Step block
12	2	Step clamp
13	2	Hex-head nut
14	2	Threaded shank
15	2	T-nut
16	2	Electrical panel keys
17	1	Ethernet cable

2.5. OPTIONAL ACCESSORIES

Intelitek offers a variety of milling center accessories, CAM software, curriculum, and documentation.

For more information about these products call your Intelitek dealer, call Intelitek directly at (800)221-2763 or (603) 413-2600, or browse our web site www.intelitek.com.

3. Installing the Hardware and Software

This section presents instructions for installing the hardware and software components.

Procedure Outline: Installation			
No.	Step	Section	Page
1	Prepare your hardware for installation.	3.1	14
2	Install the hardware.	3.2	18
3	Install and configure the software.	3.3	20

This section also presents the following information.

Section Contents: Installing the Hardware and Software		
Section	Name	Page
3.4	Contacting Technical Support	33
3.5	Returning Defective Products	33

3.1. PREPARING FOR INSTALLATION

This section presents instructions for preparing the work space and machine for installation.

Procedure Outline: Preparing for Installation		
No.	Step	Page
1	Verify that the computer to be used with the milling center meets minimum requirements.	14
2	Prepare a work space for the milling center.	15
3	Remove the crating.	15
4	Unpack and set up the milling center.	16
5	Check your shipment to ensure that all items ordered are present and undamaged.	16
6	Register your milling center to activate the warranty.	17

3.1.1. Verifying Computer Requirements

Use the checklist below to ensure that the computer that will be attached to the milling center meets minimum requirements.

Checklist: Verifying Computer Requirements

- Windows 7/Windows 8/Windows 10 - 32 or 64bit
- 512 MB RAM (1 GB Recommended)
- CD-ROM
- 100 MB of available hard drive space (300 MB Recommended)
- VGA graphics or better graphics display (minimum 256 colors)
- Available Ethernet port
- A mouse or other pointing device
- ATX Power Supply (Recommended)

Note: Your operating system might have additional hardware requirements.

3.1.2. Preparing the Work Space

Use the checklist below to ensure that the work space is ready for the installation of the machine.

Checklist: Preparing the Work Space

- For customers in the U.S.A.: A 120VAC, 15 Amp outlet
- For international customers: A 220VAC, 8 Amp outlet
- A personal computer running Windows 95 or Windows NT version 3.51 (or higher). See section 3.3.1 Verifying Computer Requirements, pg. 20, for a complete list of the necessary computer equipment.



We recommend the use of a voltage surge protector and line filter to protect your computer system.

Product Care

3.1.3. Removing the Crating

Follow the procedure below when removing the crating after delivery of the product.

Procedure: Removing the Crating

1. Inspect the crating for any visible signs of damage. If there is damage to the crating, contact the shipping company and Intelitek Customer Support.
2. Cut any banding on the outside of the crate.
3. Remove the top of the crate.
4. Remove the sides of the crate.



Intelitek is not responsible for any damage caused during shipping when components are not returned in the original packing materials.

Store the packing materials at least until the installation is complete and proper operation has been verified.

Take Note

3.1.4. Unpacking and Setting up the Milling Center

Follow this procedure for unpacking and setting up the milling center.

Procedure: Unpacking and Setting up the Milling Center

1. Position the pallet near the location at which you'll set the milling center.
2. Remove the staples that attach the bottom of the cardboard container to the pallet.
3. Cut the banding around the container.
4. Lift the cardboard cover off the top of the container.
5. Remove the sides of the container.
6. Inspect the milling center chassis for signs of visual damage such as a broken shield, a dent in the chassis, or damaged cables.
7. Call Intelitek Customer Support if any damage is noted.
8. Remove the four bolts that hold the milling center base to the pallet, using a 19mm wrench.
9. Store the bolts and other packaging materials, in case the product has to be returned or transported.
10. Lift the milling center off of the pallet and place it at its designated location.
11. Position the milling center correctly for milling.
12. Remove the protective paper from the safety door.
13. Open the front door and remove the components from the enclosure.

3.1.5. Checking your Shipment

Follow this procedure for checking your shipment once unpacked.

Procedure: Checking your Shipment

1. Locate the packing slip. This slip lists all of the items you should have received with your milling center.
2. Check that all items on the packing slip are present. See the checklist below.
3. Contact Intelitek Customer Support immediately if any item is missing.

Use this checklist to ensure that all items listed on the packing slip are present in the delivery.

Checklist: Checking your Shipment

No.	Item
1	ProMill 8000 Milling Center
2	Installation disk for CNCBase/Motion software
3	Documentation pack

4	<p>Accessory kit</p> <p>The accessory kit should include the following:</p> 	<table border="1"> <thead> <tr> <th>Item</th> <th>Qty</th> <th>Description</th> </tr> </thead> <tbody> <tr> <td>1</td> <td>1</td> <td>ISO 20 Tool holder</td> </tr> <tr> <td>2</td> <td>1</td> <td>ER 16 Collet - 4mm diameter</td> </tr> <tr> <td>3</td> <td>1</td> <td>3mm End mill 3mm shank</td> </tr> <tr> <td>4</td> <td>1</td> <td>1/8" End mill 1/8" shank</td> </tr> <tr> <td>5</td> <td>1</td> <td>Tool holder wrench - 30mm</td> </tr> <tr> <td>6</td> <td>1</td> <td>5mm x 20mm Fuse</td> </tr> <tr> <td>7</td> <td>1</td> <td>Allen wrenches, set of 6</td> </tr> <tr> <td>8</td> <td>1</td> <td>CNCBase control software</td> </tr> <tr> <td>9</td> <td>1</td> <td>Open-ended wrenches, set of 3</td> </tr> <tr> <td>10</td> <td>1</td> <td>Tool holder nut wrench</td> </tr> <tr> <td>11</td> <td>2</td> <td>Step block</td> </tr> <tr> <td>12</td> <td>2</td> <td>Step clamp</td> </tr> <tr> <td>13</td> <td>2</td> <td>Hex-head nut</td> </tr> <tr> <td>14</td> <td>2</td> <td>Threaded shank</td> </tr> <tr> <td>15</td> <td>2</td> <td>T-nut</td> </tr> <tr> <td>16</td> <td>2</td> <td>Electrical panel keys</td> </tr> <tr> <td>17</td> <td>1</td> <td>Ethernet cable</td> </tr> </tbody> </table>	Item	Qty	Description	1	1	ISO 20 Tool holder	2	1	ER 16 Collet - 4mm diameter	3	1	3mm End mill 3mm shank	4	1	1/8" End mill 1/8" shank	5	1	Tool holder wrench - 30mm	6	1	5mm x 20mm Fuse	7	1	Allen wrenches, set of 6	8	1	CNCBase control software	9	1	Open-ended wrenches, set of 3	10	1	Tool holder nut wrench	11	2	Step block	12	2	Step clamp	13	2	Hex-head nut	14	2	Threaded shank	15	2	T-nut	16	2	Electrical panel keys	17	1	Ethernet cable
Item	Qty	Description																																																						
1	1	ISO 20 Tool holder																																																						
2	1	ER 16 Collet - 4mm diameter																																																						
3	1	3mm End mill 3mm shank																																																						
4	1	1/8" End mill 1/8" shank																																																						
5	1	Tool holder wrench - 30mm																																																						
6	1	5mm x 20mm Fuse																																																						
7	1	Allen wrenches, set of 6																																																						
8	1	CNCBase control software																																																						
9	1	Open-ended wrenches, set of 3																																																						
10	1	Tool holder nut wrench																																																						
11	2	Step block																																																						
12	2	Step clamp																																																						
13	2	Hex-head nut																																																						
14	2	Threaded shank																																																						
15	2	T-nut																																																						
16	2	Electrical panel keys																																																						
17	1	Ethernet cable																																																						
5	Additional accessories ordered																																																							

3.1.6. Registering Your Milling Center

Follow this procedure to register your milling center.

Procedure: Registering Your Milling Center
<ol style="list-style-type: none"> 1. Locate the box that contains the documentation and installation disk. 2. Locate the registration card within that box. 3. Complete the card, printing all information clearly. 4. Return the card to Intelitek Customer Support at the address below,

Intelitek Customer Support
 18 Tsienneto Road
 Derry, NH 03039
 USA
 or fax to 603-625-2137

3.2. INSTALLING THE HARDWARE

This section presents instructions for installing the ProMill 8000 hardware.

Procedure Outline: Hardware Installation			
No.	Step	Section	Page
1	Connect the milling center to a computer.	3.2.1	18
2	Connect the milling center to a power source.	3.2.2	19
3	Install additional accessories purchased.	3.2.3	19

3.2.1. Connecting the Milling Center to a Computer

Follow the procedure below to connect the milling center to a computer.

You will connect the milling center directly to a computer. Connection to the network (if required) is provisioned by the computer.



Do not connect power to the milling center or the computer until instructed to do so in the following procedures.

Safety

Procedure: Connecting the Milling Center to a Computer
<ol style="list-style-type: none"> 1. If not done previously, verify that the computer you are planning to use meets minimum requirements. See 3.1.1 Verifying Computer Requirements, pg. 14.

2. Use a cable with 8P8C (RJ-45) connectors at both ends to connect the milling center to the computer, as shown below.



3.2.2. Connecting the Power



Safety

The milling center has an AC power cord terminated by a three-prong plug. The power cord should be plugged into a three-hole, grounded receptacle. If a grounding adapter is used to accommodate a two-prong receptacle, the adapter wire must be attached to a known ground. Never remove the third prong from the plug on the AC power cord.

Follow the procedure below to connect the milling center to a power supply.

Procedure: Connecting the Power

1. Ensure that the milling center's power switch, located at its side, is set to the OFF position.
2. Connect the power cord from the milling center to the power source.

3.2.3. ProMill 8000 Installing Accessories

Each accessory kit is supplied with an installation guide.



Safety

To avoid stressing the milling center and creating a hazardous milling environment, use only those accessories designed for use with the ProMill milling center, available through Intelitek Corporation.



Complete the hardware and software installation procedures (see 3.3 Installing the Software below), and test the functioning of the basic machine, before installing accessories.

Product Care

3.3. INSTALLING THE SOFTWARE

This section presents instructions for installing the control software (CNCMotion or CNCBase) on the computer.

Procedure Outline: Software Installation			
No.	Step	Section	Page
1	Ensure that your computer meets the minimum requirements.	3.3.1	20
2	Run the installation to install the software.	3.3.2	21
3	Configure the software for your machine and accessories.	3.3.4	25
4	Configure the IP address of the milling center	3.3.5	29

This section also presents the following information:

Section Contents: Installing the Software		
Section	Name	Page
3.3.6	Uninstalling the Software	31

3.3.1. Verifying Computer Requirements

If not done previously, verify that the computer you are planning to use meets the minimum requirements. See 3.1.1 Verifying Computer Requirements, pg. 14.

If installing the software on a computer to be used only for writing and verifying NC programs, but not for interacting with the hardware itself, the requirement for LAN cards is not relevant.

3.3.2. Running the Installation

Follow the procedure below to run the installation.

Procedure: Running the Installation

1. Insert the installation disk into the CD/DVD drive. The installation program should open automatically.
If the installation does not open automatically, navigate to the *Install* folder and launch the program **iCNC.exe**.
2. If the User Account Control message displays, click **Yes**.

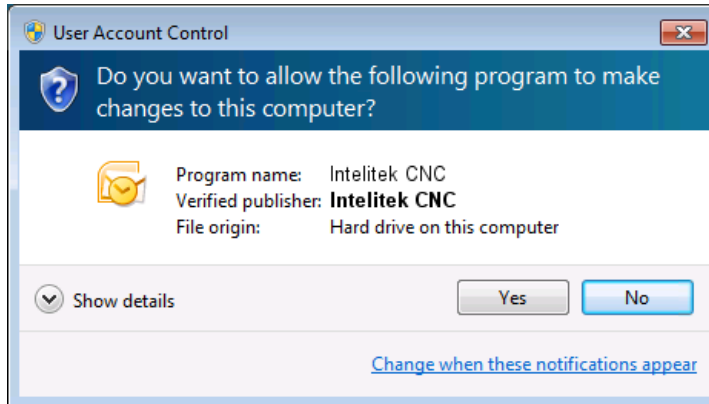

The installation begins and the Welcome screen is displayed.

3. Click **Next**.

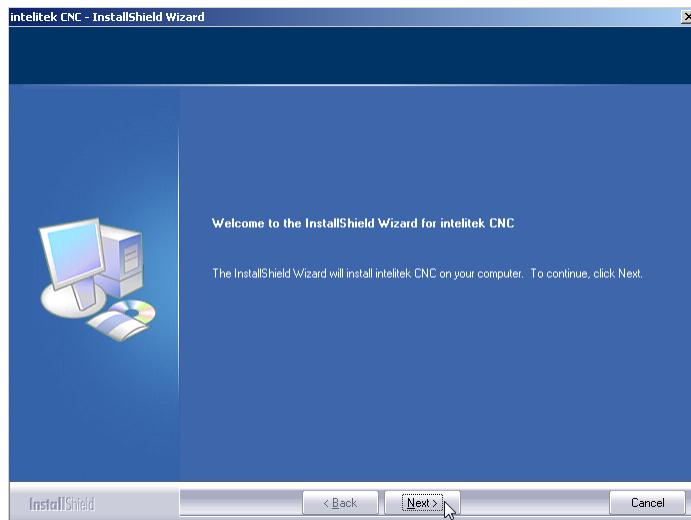

The License Agreement is displayed.

4. Click **Yes** to accept and continue.

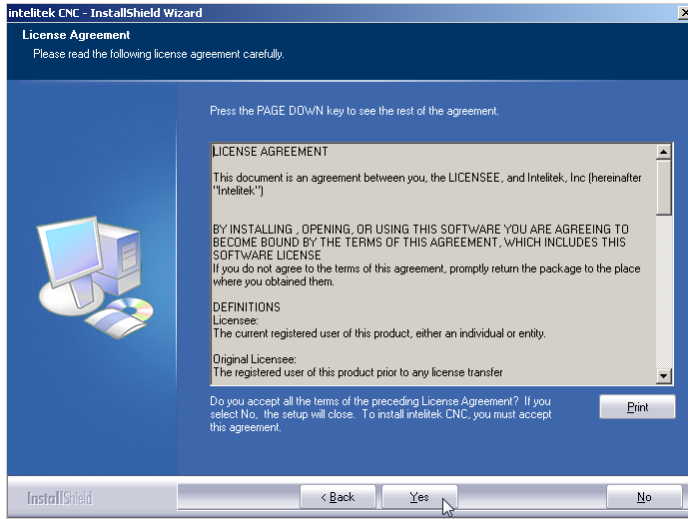

The Software Selection screen is displayed.

5. Select the software to install. It is important that the software you select here matches the license you have purchased.

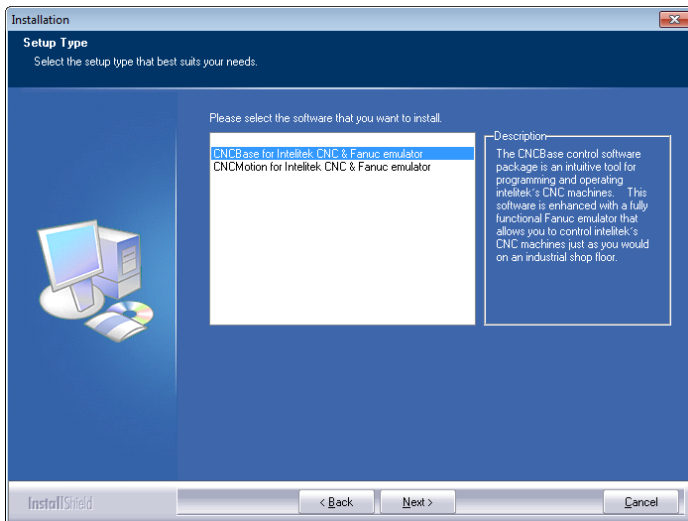

6. Click **Next**.

The Machine Selection screen is displayed.

7. Select the machine you will be using. It is important that the machine selected matches the license you have purchased.

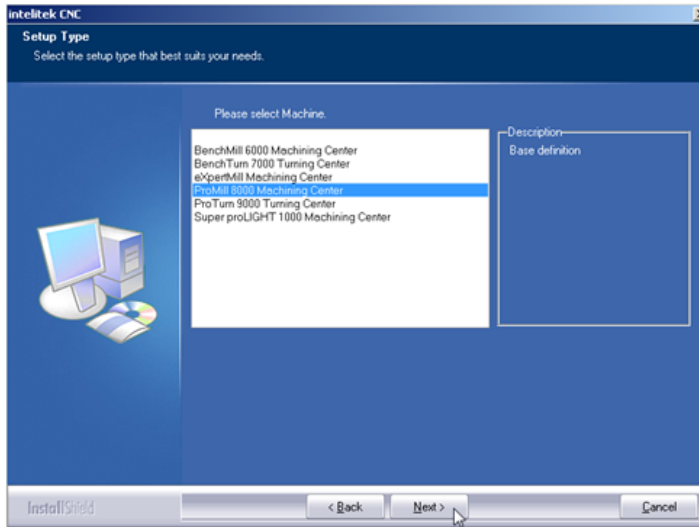

8. Click **Next**.

The Configuration Options screen is displayed.

9. Select whether the configuration and sample programs are to be exclusive to each user (first option) or common to all users (second option). The first option is recommended when running software in simulation mode. The second option is highly recommended when running software with a physical CNC machine.

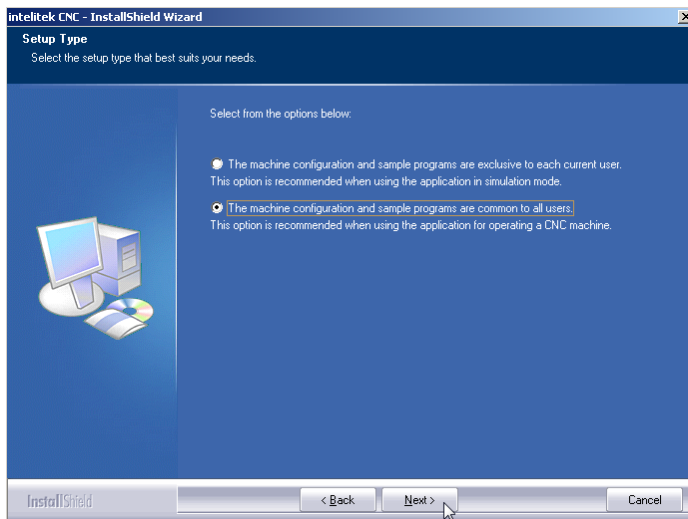

10. Click **Next**.

The Choose Destination Location screen is displayed.

11. If necessary, click **Browse** to change the destination folder.

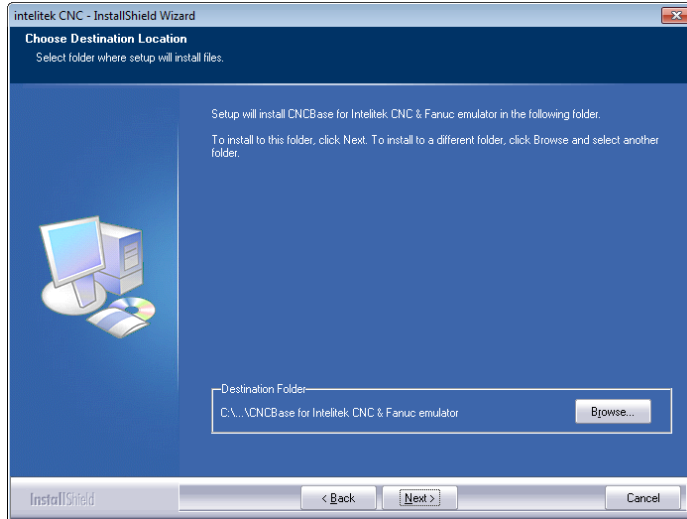

12. Click **Next**.

The Ready to Install screen is displayed.

13. Click **Install**.

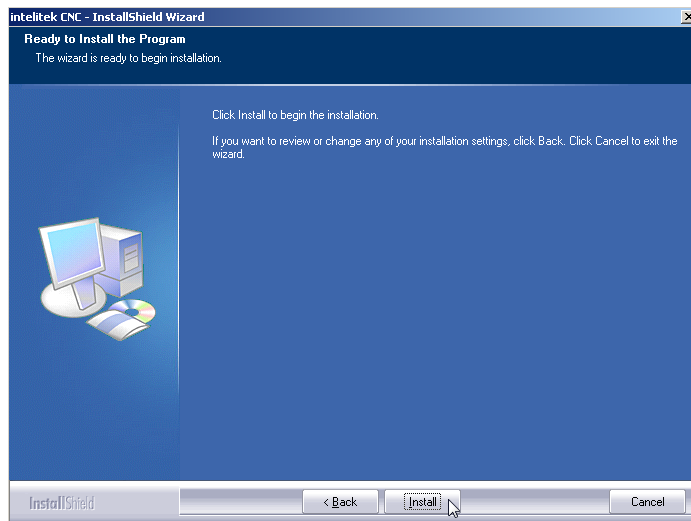

14. Wait while installation is performed.

The InstallShield Wizard Complete screen is displayed.

15. Select **Yes, I want to restart my computer now.**

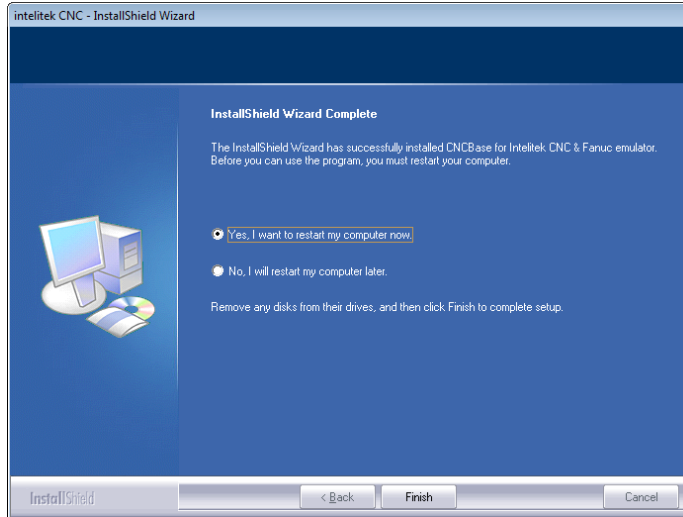

16. Click **Finish.**

Your computer will restart and installation will be finalized.

3.3.3. Licensing the Software

For details on licensing your software and managing or transferring your license, refer to the Licensing Help document that can be found in the Books folder of the software installation disk. You can also access the Licensing Help document by clicking the Help button during software registration.

Note that CNCBase does not require registration. If you have purchased CNCMotion, that software does require registration.

3.3.4. Configuring the Software

The installation program automatically configures most software parameters based on the selections you make during installation.

The Configuration Program can be used to:

- Modify selections made during installation.
- Configure machine accessories installed.

This section presents instructions for configuring the control software (CNCMotion or CNCBase) on the computer.

Procedure Outline: Configuring the Software			
No.	Step	Section	Page
1	Run the configuration program.	3.3.4.1	20
2	Change configuration settings using the configuration program.	3.3.4.2	21

3	Add optional accessories to the machine.	3.3.4.3	28
---	--	---------	----

3.3.4.1. Running the Configuration Program

The Configuration Program is launched from your Windows Start menu.

If you try to launch the Configuration Program while the CNCBase/Motion software is open, you will be asked to close CNCBase/Motion first.

Procedure: Running the Configuration Program

1. Ensure that CNCBase/Motion is not currently running.
2. Click the Windows Start button. 
3. Click **All Programs**.
4. Locate and click the **CNCBase/Motion for Intelitek CNC & Fanuc emulator** folder.
5. Click **CNCBase/Motion Configuration**.

The CNC Configuration window displays.





3.3.4.2. Using the Configuration Program

The table below summarizes the use of the configuration program.

Procedures: Using the Configuration Program	
To	Instructions
View all available settings	Click the tabs at the top of the window.
Access online help	Click the Help button.
Save changes made	Click OK . Clicking OK will close the configuration program. Make all required changes before clicking OK.

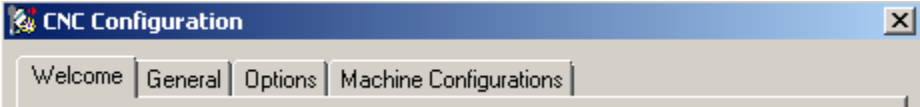
The table below summarizes the configuration options available on each of the four tabs of the CNC Configuration Program.

Info Table: CNC Configuration Program Tabs		
		
Tab	Main Options	
Welcome	Units (Inch or Metric)	

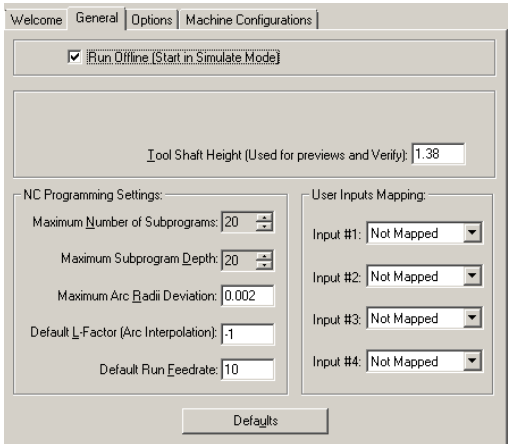
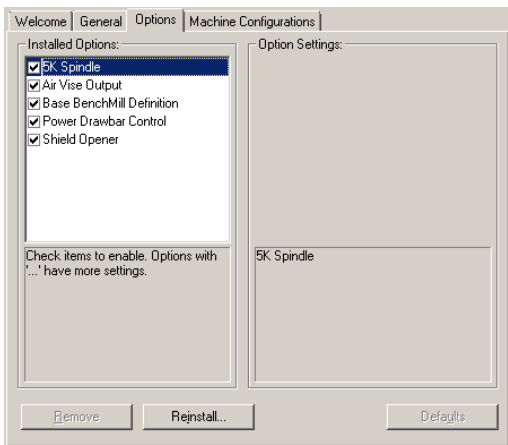
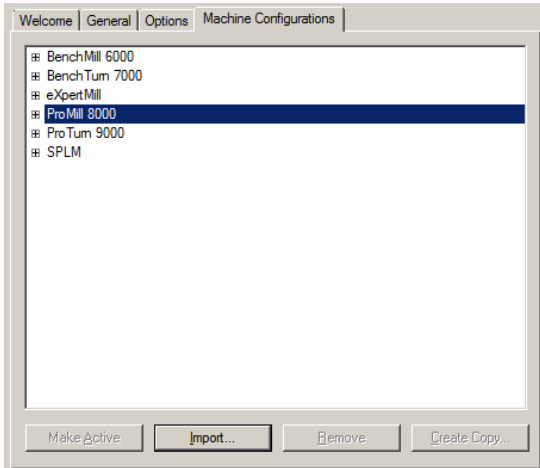
<p>General</p>	<p>Run in offline (simulation) or online mode. For more information on switching between offline and online modes, see 5.2 Selecting Online or Simulation Mode, pg. 44.</p> <p>NC programming settings</p> <p>User inputs mapping</p>	
<p>Options</p>	<p>Lists installed options and allows you to install addition options. Click Reinstall to install others.</p> <p>For more information, see 3.3.4.3 Adding Installed Optional Accessories, pg. 28.</p>	
<p>Machine Configuration</p>	<p>Allows you to select a different machine, and to save and load previously defined configurations.</p>	

3.3.4.3. Adding Installed Optional Accessories

Optional accessories are available for the ProMill 8000 (see 2.5 Optional Accessories, pg. 13). After installing the accessory hardware, the control software must be reconfigured.

Detailed instructions are provided in the installation guide supplied with each accessory. General instructions are provided below.

Follow the procedure below to configure the control software for a new accessory.

Procedure: Configuring Control Software for New Accessory

1. Run the configuration program. (See 3.3.4.1 Running the Configuration Program, pg. 26.)
2. Click the **Options** tab.

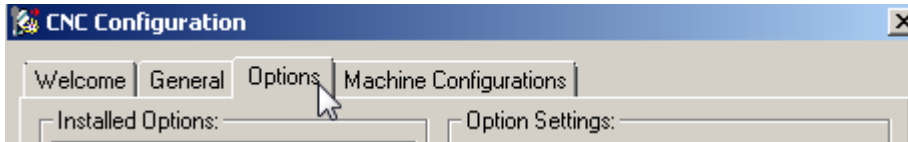

3. Click **Reinstall**.



The Reinstall Options window is displayed.

4. Select the option to be added.



5. Click **Reinstall**.



The Reinstall Options window closes. The selected option is now listed in the Installed Options list.

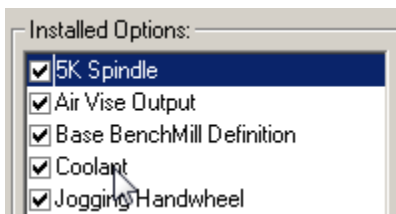

3.3.5. Configuring the IP Address

Before using the hardware, you must configure its IP address on the network.

This utility configures the IP address of the computer's LAN adapter.



You must have administrator access to your computer to run the Machine IP Changer utility.

Take Note



To reconnect to the network over the LAN, you will need to restore the settings of your LAN adapter.

Take Note

Follow the procedure below to configure the IP address.

Procedure: Configuring the IP Address

1. Run the Machine IP Configuration utility. To do so, locate the CNCBase/Motion for Intelitek CNC & Fanuc emulator folder and click **Machine IP Configuration**.
2. Click **Yes** if asked for permission.

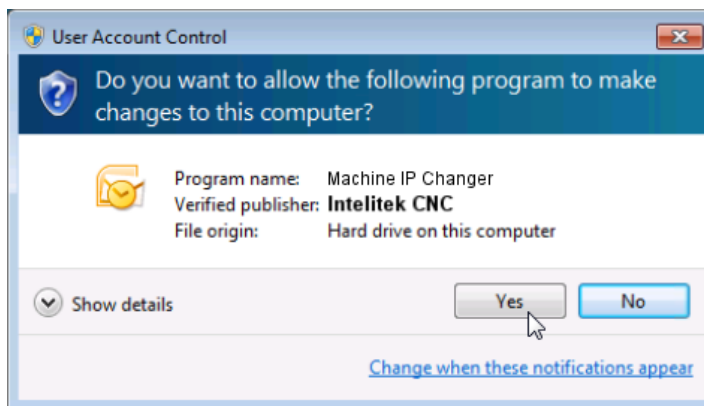

3. From the dropdown list, select the local area network or network card that you wish to use for the CNC machine.

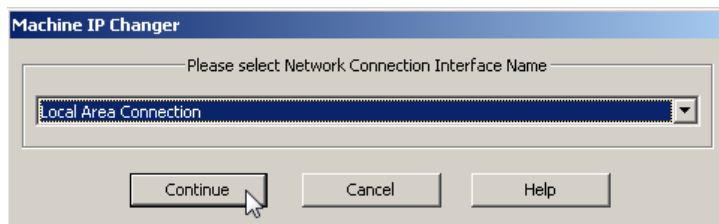

4. Click **Continue**.

5. Click **Yes** when asked for confirmation of your selection.

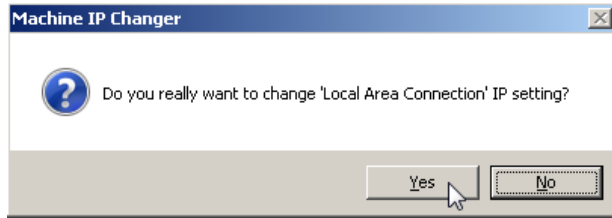

When the process is finished, Machine IP Changer displays the configuration for all active network connections.

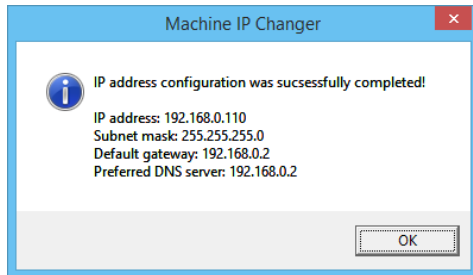

6. Click **OK** to close the program.

3.3.6. Uninstalling the Software

When necessary, follow the procedure below to uninstall the software.

Procedure: Uninstalling the Software

1. Click the Windows Start button. 
2. Click **All Programs**.
3. Locate and click the **CNCBase/Motion for Intelitek CNC & Fanuc emulator** folder.
4. Click **Uninstall**.

5. Click **Yes** if the User Account Control message displays.

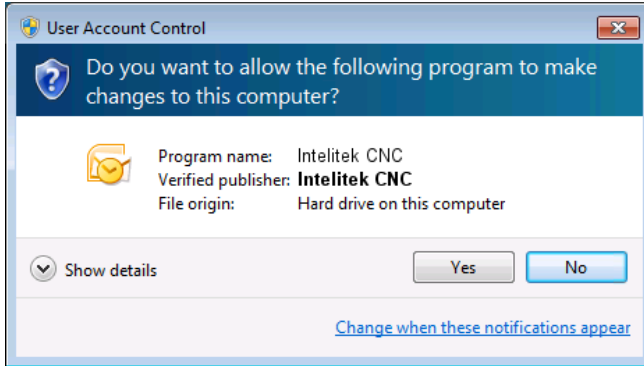

The Uninstall Wizard is displayed, asking for confirmation.

6. Click **Yes** to uninstall CNCBase/Motion.



7. Wait while the software is uninstalled.

The Uninstall Complete window is displayed.

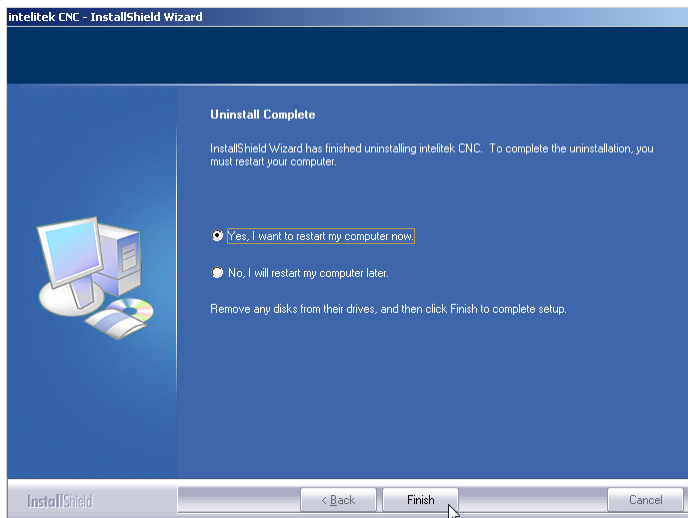

8. Select **Yes, I want to restart my computer now.**

9. Click **Finish.**

Your computer will restart and uninstallation will be finalized.

3.4. CONTACTING TECHNICAL SUPPORT

Should you require technical assistance, contact your local Intelitek dealer. If you are unable to resolve your problem through your local dealer, free technical support is available by phone or email from 8:15 A.M. to 5:00 P.M. EST.

Make sure you have the following information gathered before contacting our Technical Support group.

Info Table: Requirements for Technical Support	
The product serial number	
The name of the owner of the product	
The specifications of your computer (e.g. version of Windows, hard drive size, clock speed, etc.)	
Notes on any error messages received	



Take Note

When you call, make sure you have access to both your milling center and your computer. This will allow our technical support representatives to walk through the problem with you.

Technical support contact details:

Info Table: Intelitek Technical Support Contact Details	
Toll-free (U.S. only)	(800) 221-2763
Direct Dial	(603) 413-2600
e-mail	support@intelitek.com
Web site	www.intelitek.com

3.5. RETURNING DEFECTIVE PRODUCTS

Intelitek products (excluding software) carry a one-year limited warranty from date of purchase. Defective products may be returned for repair or replacement according to the conditions outlined in the Terms and Conditions of Sale agreement.



Take Note

Intelitek will not be responsible for any damage incurred during shipping when components are not returned in the original packing materials.

Follow the procedure below to return defective products.

Procedure: Returning Defective Products
<ol style="list-style-type: none"> 1. Contact Intelitek Technical Support and describe the problem. 2. If the Technical Support representative decides that the product is defective and has to be returned, the Technical Support representative will issue a Return Materials Authorization number (RMA). Store this

number safely.

- 3.** Pack the product to be returned in its original packaging and crate, as was packed originally.
- 4.** Write the RMA number and your return address on the outside of the product carton or crate. Failure to do so can result in a delay in the return of your product.
- 5.** Have the package returned to Intelitek's offices, as directed by the Technical Support representative.

4. Maintaining the ProMill 8000



Preventative maintenance of the ProMill 8000 is essential for ensuring a long and trouble-free service life.

Product Care

This section presents instructions for maintaining the milling center and computer.

Maintaining the Milling Center		
Description	Section	Page
Keep the machine clean.	4.1	35
Maintaining individual milling machine components.	4.2	36
Follow a maintenance schedule.	4.3	38
Adjust the pneumatic systems.	4.4	39
Maintaining a computer in a shop environment.	4.4	39

4.1. CLEANING THE MILLING CENTER

Keeping your machine clean is the easiest and most important maintenance practice.

Checklist: Cleaning the Milling Center
<ul style="list-style-type: none"> Remove all chips from the machine after every use. Pay particular attention to the bellows. If chips build up on top of the bellows, they may fall behind the bellows and interfere with ball screw operation.



If you clean a component of the milling center that requires lubrication, make sure to relubricate it after cleaning.

Product Care

4.2. MAINTAINING INDIVIDUAL MILLING MACHINE COMPONENTS

Each of the milling center’s major components must undergo routine maintenance.

This section provides maintenance instructions for each major component.

These tasks provide maintenance instructions for each major component:

Maintaining the Milling Center Components		
Task	Section	Page
Maintaining the Milling Machine Bed	4.2.1	36
Maintaining the Milling Machine Bed Linear Bearings	4.2.2	37
Maintaining the Ball Screw	4.2.3	37
Maintaining the Spindle Motor Belt	4.2.4	38

4.2.1. Maintaining the Milling Machine Bed

The milling machine bed, saddle, and ball screw all require constant lubrication to prevent wear and rust. The ProMill 8000 is supplied with a one-shot system that simplifies lubrication of these components.



Use 15 weight way oil only.

Product Care

Follow the guidelines below to ensure proper lubrication of the milling machine bed.

Guidelines: Lubricating the Milling Machine Bed

- Operate the one-shot lubricating system before each use.
- To operate, pull on the handle of the one-shot lubricating system and release.
- Keep the reservoir filled with 15 weight way oil.
- Maintain a film of lubricant on the surface of the milling machine bed to minimize friction and wear.
- Ensure that all non-painted surfaces on the milling machine are coated with oil to prevent rust.



4.2.2. Maintaining the Milling Machine Bed Linear Bearings

Play in the table could indicate that the milling machine bed bearings require adjustment. The bearings are factory-adjusted and should be checked at least every three months.

Contact your Intelitek customer service group for maintenance or service instructions.

4.2.3. Maintaining the Ball Screw

The ProMill 8000 Milling Center uses pre-loaded ball screws on both axes. The screws are lubricated at the factory with a special long-life, waterproof ball screw lubricant. Additionally, the ball screw is lubricated via the one-shot lubrication system.

One-shot lubrication should be performed before each use of the machine. See 4.2.1 Maintaining the Milling Machine Bed, pg. 36, for instructions.

4.2.4. Maintaining the Spindle Motor Belt

The spindle motor belt will wear out quickly if it becomes loose. If a belt squeals at slow speeds, it may be loose or worn.

The spindle drive belt is inside the spindle head.



Call Intelitek Customer Service if the belt makes a squealing sound.

Product Care

4.3. MAINTENANCE SCHEDULE SUMMARY

Follow the maintenance schedule outlined in the table below.

Guidelines: Maintenance Schedule					
	Continuously	Before Every Use	After Every Use	Every 2 Months	Every 3 Months
Clean chips from the milling center			X		
Coat exposed surfaces with light oil			X		
Activate the one-shot lubrication system		X			
Maintain the level of 15 weight way oil in the one-shot lubricating system	X				
Check and adjust the milling machine bed linear bearings					X

4.4. ADJUSTING AND MAINTAINING THE PNEUMATIC SYSTEMS

Both the ATC and the drawbar air-blast are pneumatically powered. The pneumatic controls for both systems are located in the rear pneumatics panel, as shown below.

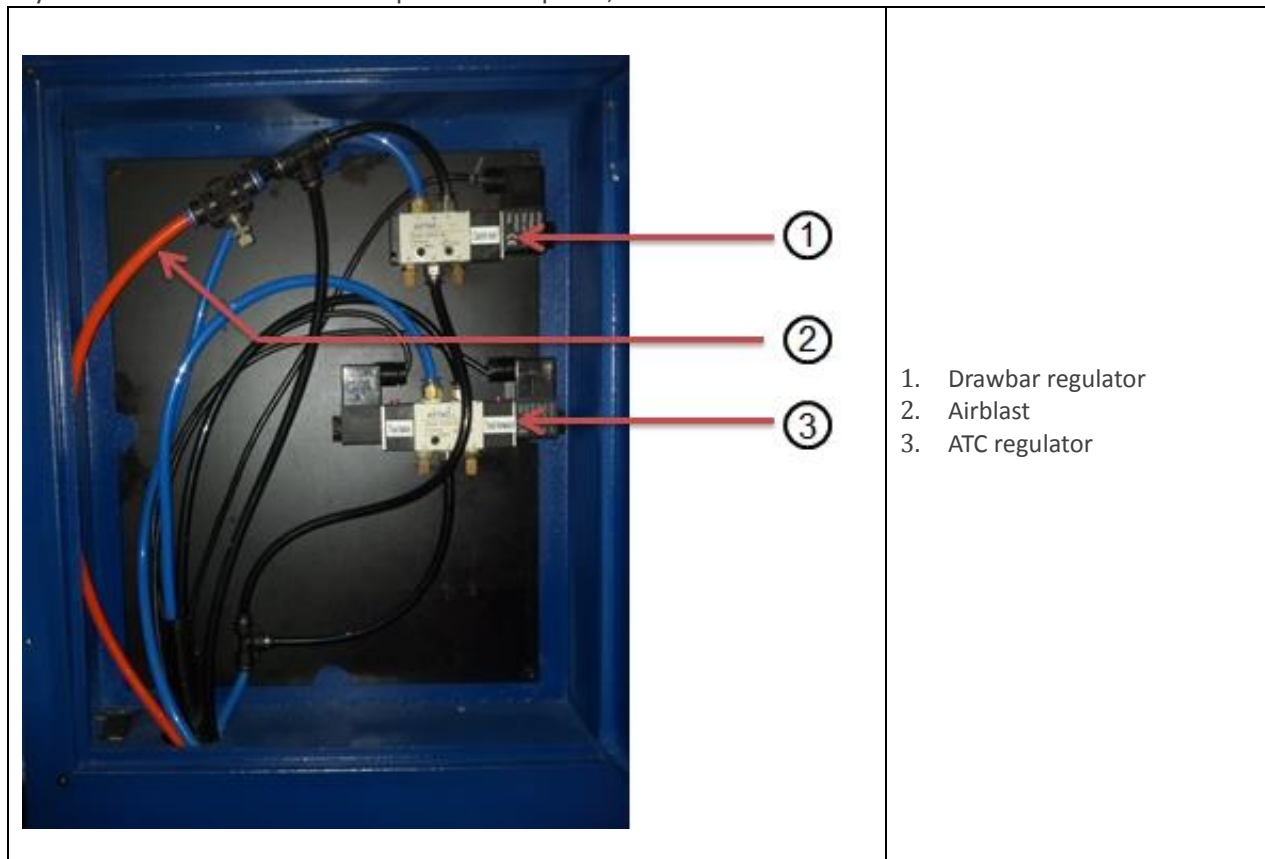

This section presents the following information:

Section Contents: Adjusting and Maintaining Pneumatic Systems		
Section	Name	Page
4.4.1	Adjusting the Flow Controls	40
4.4.2	Adjusting the Air Pressure	40
4.4.3	Maintaining the Pneumatic Oil	40

4.4.1. Adjusting the Flow Controls

The three flow control units are located in the rear pneumatics panel. The flow control units are adjusted as follows:

Info Table: Adjusting Pneumatic Flow Controls	
	Orange Pipe
Turn Clockwise (Close)	Reduce air-blast pressure
Turn Counter-clockwise (Open)	Increase air-blast pressure

4.4.2. Adjusting the Air Pressure

The air pressure should be set to 80 psi. The air pressure is adjusted using the control unit on the regulator, located on the right side of the machine.

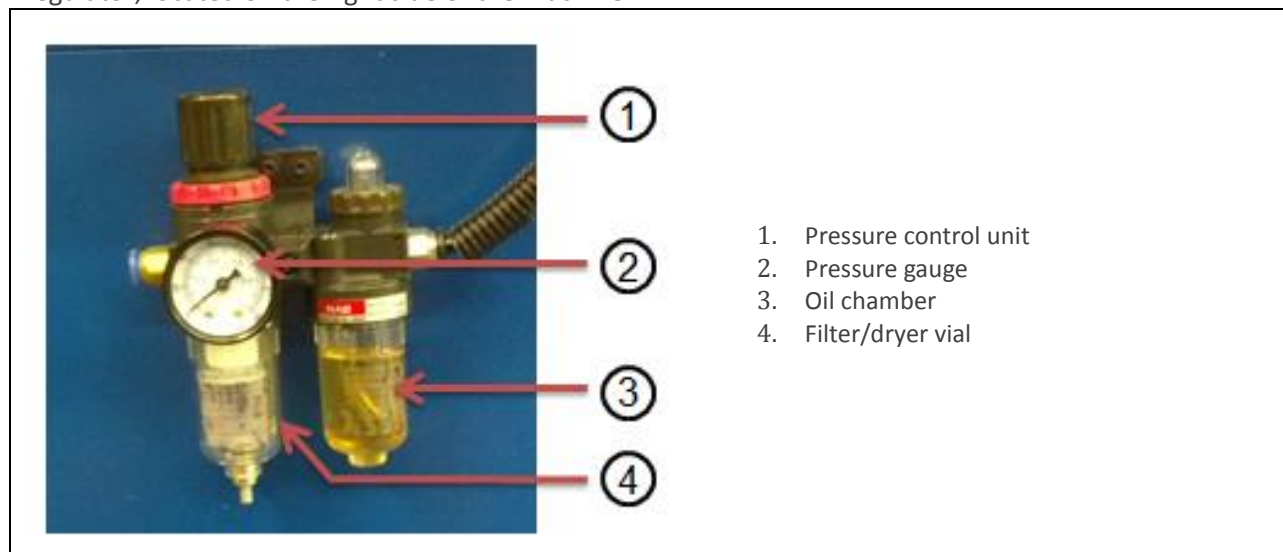

4.4.3. Maintaining the Pneumatic Oil

The oil flow rate is factory-adjusted and does not require maintenance.

The oil level in the oil chamber (see picture above) should be checked regularly and filled when empty. Use standard pneumatic tool oil only.

4.5. MAINTAINING THE PC IN A SHOP ENVIRONMENT

Maintaining a personal computer and software in a shop environment requires extra precautionary measures. See your owner's manual for maintenance procedures specific to your computer.

Follow the guidelines listed in this table.

Guidelines: Maintaining the PC in a Shop Environment
<ul style="list-style-type: none">• Keep the computer and peripherals (mouse, keyboard, external drive, printer, etc.) out of direct sunlight, away from sources of heat, and in a relatively clean environment (i.e., not right next to the foundry room).• Keep liquids (soda, coffee, cutting fluid, grease) away from the computer and peripherals.• Keep oil, grease, metal chips and excess dust away from the computer, keyboard and other peripherals. Consider erecting a clear plastic shield between the computer and the milling machine to keep chips off the computer.• Use grounded three-prong outlets for the computer and peripherals. Take precautions against current overload. A line-surge suppression unit can be purchased at your local computer store to help alleviate this problem.• Don't block the vent holes in the computer or drives; they are required for air circulation.

5. Using the Control Software

The control software, CNCBase or CNCMotion, is used to control all aspects of machine function, to edit and run NC programs, and to verify those programs in simulation mode. CNCMotion additionally provides 3D simulation of the milling procedure.

For installation and configuration instructions, see 3.3 Installing the Software.

This section presents the following information.

Section Contents: Control Software		
Section	Name	Page
5.1	Launching the Control Software	42
5.2	Selecting Online or Simulation Mode	44
0	Software Interface	45
5.4	Homing	61
5.5	Opening an NC File	62
5.6	Verifying an NC Program	64
5.7	Running an NC Program	71
5.8	Accessing Help	72

5.1. LAUNCHING THE CONTROL SOFTWARE

CNCBase/Motion can be used with or without the milling center attached to the computer. If you intend to use the milling center, follow these safety guidelines before launching the software.



Safety

1. The safety door should be closed, and the Emergency Stop button released, before launching the software in on-line mode.
2. The milling center must be powered up and connected to the computer before launching the software in on-line mode.
3. Review the complete guidelines in chapter 1 Safety Guidelines, pg. 1.

Follow this procedure to launch the control software.

Procedure: Launching the Control Software

1. If you intend to use the milling center, follow the safety information above.



2. Click the Windows Start button.
3. Click **All Programs**.

4. Locate and click the **CNCBase/Motion for Intelitek CNC** folder.



5. Click **CNCBase/Motion for Intelitek CNC**

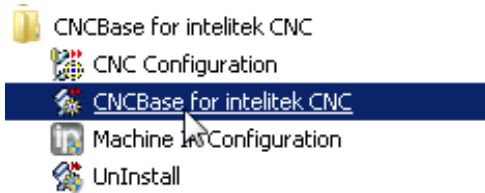

6. Click **No** if the message below displays. This message is only displayed the first time the software is run after installation.

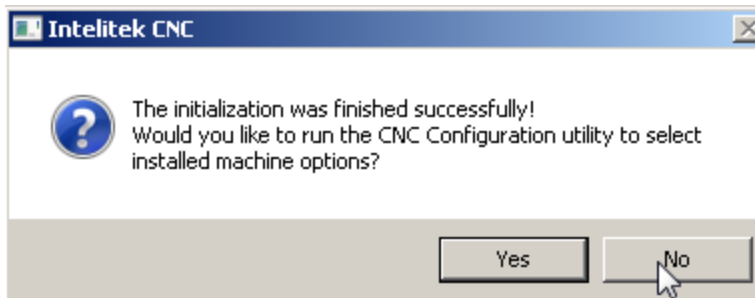

The software opens.

5.2. SELECTING ONLINE OR SIMULATION MODE

Both CNCBase and CNCMotion can be run in two modes:

- **On-line mode**

For use when controlling the ProMill 8000.



Safety

1. The safety door should be closed, and the Emergency Stop button released, before launching the software in on-line mode.
2. The milling center must be powered up and connected to the computer before launching the software in on-line mode.

- **Simulation mode**

For use without the ProMill 8000 connected. In simulation mode, you can write, edit, and verify NC programs as in on-line mode, but you cannot control or send NC programs to the ProMill 8000.

Follow this procedure to toggle between on-line and simulation mode.

Procedure: Selecting On-line or Simulation Mode

1. Launch CNCBase/Motion.

2. Click **Setup** in the main menu.

The two modes are listed at the top of the Setup menu. The mode that is currently active is checked.

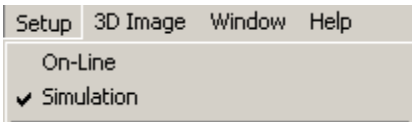

3. To change the mode, click the unchecked mode.

A confirmation message is displayed.

4. Click **Yes**.

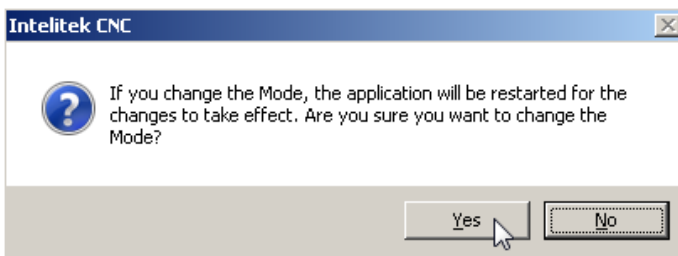

The software restarts and opens in the selected mode.

5.3. SOFTWARE INTERFACE

You should become familiar with the main parts of the control software screen prior to use.

This section provides information on the following screen areas:

Section Contents: The Software Interface		
Section	Name	Page
5.3.1	Toolbars	45
5.3.2	Information Areas	53
5.3.3	Program Editing Window	56
5.3.4	Control Panels	58

5.3.1. Toolbars

This section includes information on the following toolbars:

Section Content: Toolbars		
Section	Name	Page
5.3.1.1	Main Menu	45
5.3.1.2	Standard Toolbar	49
5.3.1.3	Tool Menu and ATC Control Toolbar	50
5.3.1.4	Outputs Toolbar	52
5.3.1.5	Inputs Toolbar	53

5.3.1.1. Main Menu

The Main Menu contains all of the menu commands. For an explanation of each menu and its relative commands, refer to the online help.

File Edit View Program Tools Setup 3D Image Window Help

This table summarizes all options listed in the main menu.

Info Table: Main Menu		
Menu	Option	Function
File	New	Opens a new, blank Program Editing window. See 5.3.3 Program Editing Window, pg. 56.
	Open	Opens an NC program that was saved previously. See 5.5 Opening an NC File, pg. 62.
	Close	Closes the currently active Program Editing window.

	Save	Saves the program in the currently active Program Editing window, using its current name.
	Save as	Saves the program in the currently active Program Editing window, under a new name that you specify.
	Print	Prints the NC program in the currently active Program Editing window.
	Print setup	Opens the Print Setup window in which you can set up a printer for printing NC programs.
	Choose machine	For selecting which NC machine configuration is in use. See 3.3.4 Configuring the Software, pg. 25.
	Save a copy of current configuration	Saves the current machine configuration, so that you can reload it later. See 3.3.4 Configuring the Software, pg. 25.
	Exit	Closes the software. If you have made any unsaved changes to an NC program, you will be asked for confirmation before closing.
Edit	Undo	Undo the most recent editing command.
	Redo	Redo the most recent Undo command.
	Cut	Cut selected text to the clipboard.
	Copy	Copy selected text to the clipboard.
	Paste	Paste text from the clipboard into the current NC program.
	Clear	Delete selected text.
	Delete Line	Delete the line the cursor is currently on.
	Find	Locate a sequence of characters in an NC program.
	Replace	Replace one sequence of characters with another, one or more times.
	Goto Line	Jump to a particular line in the NC program. Note: The Goto Line does not reference the "N" code in the NC file. The line number is counted starting at one and increments in steps of one, regardless of the numbering used in the NC code.
	Renumber	Modify or insert N codes in an NC program.
	Lock	Lock or unlock the Program Edit Window to prevent or allow modification to the NC program.
Select Font	Change the font currently being used in the Program Editing window.	
View	Actual Position	Open or close the Actual Position Window. See 5.3.2.2 Actual Position Panel, pg. 54.

	Absolute Position	Open or close the Absolute Position Window. See 5.3.2.2 Actual Position Panel, pg. 54.	
	Machine Info	Open or close the Machine Info panel. See 5.3.2.3 Machine Info Panel, pg. 55.	
	Jog Control	Open or close the Jog Control Panel. See 5.3.4.1 The Jog Control Panel, 58.	
	Operator Panel	Open or close the Operator Panel. See 5.3.4.2 The Operator Panel, pg. 60.	
	Verify Window	Open or close the Verify Window. See 5.6 Verifying an NC Program, pg. 64.	
	Toolbars	Open or close one of the toolbars.	
Program	Run/Continue	Start or resume running the current NC program. See 5.7 Running an NC Program, pg. 71.	
	Verify	Verify the current NC program. See 5.6 Verifying an NC Program, 64.	
	Estimate Runtime	Estimate the runtime of the current NC program.	
	Pause	Pause the NC program after the current line of NC code finishes executing. Spindle continues to turn.	
	Feedhold	Immediately pauses the NC program. Stops movement of all axes while the spindle continues to turn.	
	Stop	Immediately halts the currently running NC program. Stops both axes movement and spindle.	
Tool	Setup Library	Define tools.	See 5.3.1.3 Tool Menu and ATC Control Toolbar, pg. 50.
	Select Tool Wizard	Opens the Tool Height Setup Wizard. The assists in setting tool heights and offsets.	
	Select Tool...	Select a tool to use from a menu.	
	Configure ATC	Set tools for use in the ATC.	
	Operate ATC	Manually operate the ATC.	
Setup	On-line	Change from simulation mode to on-line.	
	Simulation	Click to change from on-line mode to simulation mode.	
	Set Position	Establish the X, Y, and Z position of the tool. See 5.4 Homing, pg. 61.	
	Zero Position	Set the current tool position to X=0, Y=0, Z=0. See 5.4 Homing, pg. 61.	

	Jog Settings	Establish speed and distance parameters for jogging the tool. See 5.3.4.1 The Jog Control Panel, 58.
	Run Settings	Establish options for running an NC part program. See 5.7 Running an NC Program, pg. 71.
	Verify Settings	Establish options for verifying an NC part program. See 5.6 Verifying an NC Program, 64.
	Set/Check Home	Establish or check a fixed known position on the machine. See 5.4 Homing, pg. 61.
	Goto Position	Automatically move the tool to a specific set of coordinates.
	Units	Select imperial or metric units of measure.
	Coordinate Systems	Define multiple coordinate systems.
	Offsets	Modify the table of offset values used for certain NC codes.
	Spindle	Specify a spindle speed if you have not used an S code in your NC program.
	Backlash	Define the amount of play in the turning screws.
	Soft Limits	Establish and configure software limits for each axis.
	Preferences	Establish defaults for saving files and security features.
Window	Run and Edit Screen	Loads the preset display configuration for running NC programs: Operator panel, Verify window, Machine info.
	Verify Screen	Loads the preset display configuration for verifying NC programs: Verify window, Machine info.
	Program Screen	Select how multiple NC program windows display: tiled or cascading.
	Close all windows	Closes all software panels and windows, including NC programs.
Help	Help	Opens the built-in Help system.
	Tip of the day	Shows a specific tip to help you take more advantage of the software.
	About	Shows software version and copyright information.













5.3.1.2. Standard Toolbar





The Standard Toolbar provides easy access to the most often used commands available in the software. The Standard Toolbar includes the buttons below:



When using CNCMotion, the following additional buttons are present:



Info Table: Standard Toolbar		
Icon	Name	Function
	New	Opens a new NC part program file.
	Open	Opens an existing NC part program file.
	Save	Saves the current NC part program file to disk or drive.
	Verify	Verifies the program.
	Run	Runs the current NC part program, and recommences the program after a pause.
	Pause	Causes the currently running program to pause once the current block in the NC program is complete. The program will continue from the next line once the operator resumes operation.
	Feedhold	Pauses the currently running program immediately, even if the current block in the NC program has not been fully executed. The spindle continues spinning. The program will continue from the point at which it stopped once the operator resumes operation.
	Stop	Halts the currently running NC part program.
	Home	Opens the Machine Home window.
Available in CNCMotion Only		
	Show 3D Image	Toggles the 3D display on and off.
	Redirect Camera	Initiates camera redirection: after clicking this icon, click any point on the 3D image to center the camera on that point.
	Follow Me Camera	Initiates camera following mode: after clicking this icon, click any point on the 3D image to center the camera on that point. If that point moves during simulation, the camera will readjust to keep that point at the center of focus.
	Drag Image	Initiates image dragging mode: after clicking this icon, click and drag the 3D image to reposition it within the window.



	Save Camera Position	Saves the current viewing angle and position of the 3D window. The next time you open CNCBase/Motion, that saved view will be restored automatically.
	Send Tool to Origin	Moves the tool to the workpiece origin immediately. (Available in Simulation mode only.)
	Send Tool to Point	Displays a cursor: click any point on the workpiece, and the tool will move directly to that point. (Available in Simulation mode only.)
	Reset Workpiece	Returns the workpiece to its original uncut form in the 3D window.

5.3.1.3. Tool Menu and ATC Control Toolbar

The configuration of the tools and the optional 4-position tool changer is performed in the windows listed below, all accessible from the Tools menu in the Main Menu. Some are also accessible from the ATC Control Toolbar.

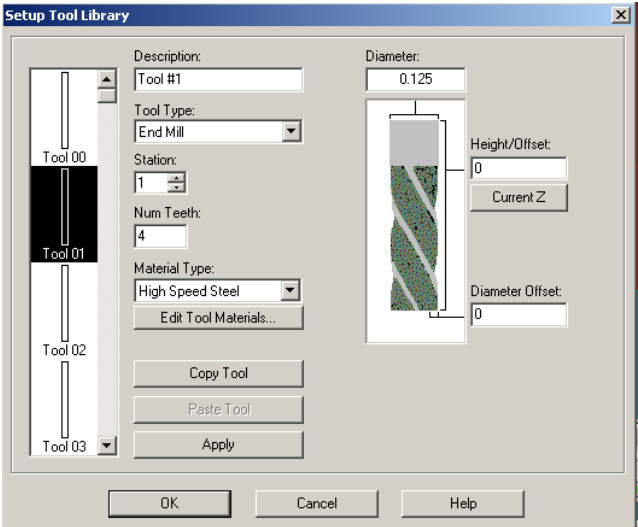

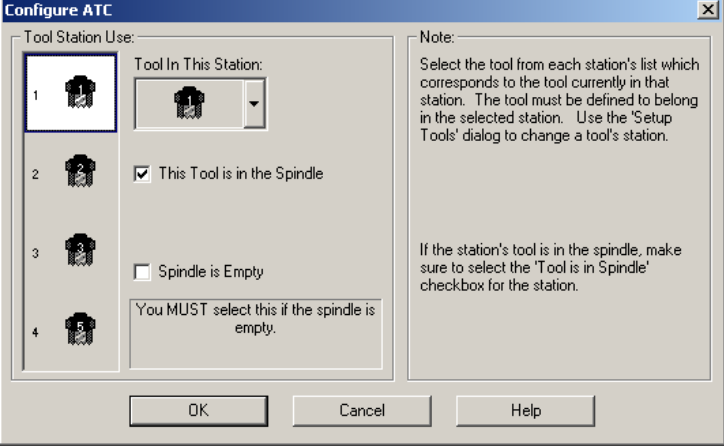
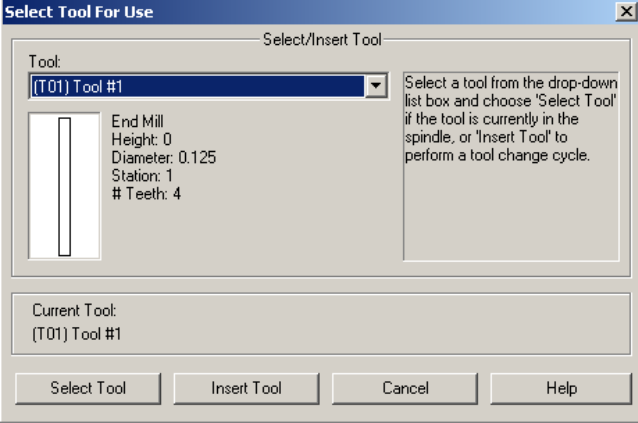

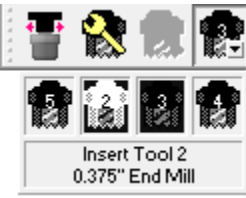

Info Table: Tool Menu and ATC Control Toolbar			
Menu Name	ATC Control Toolbar Icon	Function	Window
Tool Setup Library	-	<p>Allows you to specify the details of up to twenty tools to be used. Specifications include tool type (shape), material, radius, angle, and more.</p> <p>Click any tool listed in the left panel, edit its specifications, and click OK to save.</p>	

<p>Configure ATC</p>		<p>Opens the Configure ATC window. In this window you specify which tool is positioned in each of the tool ATC locations.</p> <p>The tools must first be defined using the Setup Tool Library window.</p>	 <p>Select a tool station from the <i>Tool Station Use</i> drop-down list. Select the tool that is positioned in that station from the <i>Tool in This Station</i> drop-down list.</p>
<p>Select Tool</p>	<p>-</p>	<p>Opens the Select Tool for Use window.</p> <p>This window allows you to select a different tool to be moved to milling position.</p>	 <p>The Tool drop-down list lists all tools defined in the Configure ATC window.</p> <p>If you select a tool that is:</p> <ul style="list-style-type: none"> Currently configured within the ATC (in the Configure ATC window), then click Change Tool. The machine will move to load the new tool in the spindle. Not configured within the tool ATC, click Select Tool. The Configure ATC window is displayed.
<p>Select Tool From</p>		<p>Indicates which tool is currently in the spindle, and allows you to select a different tool to be inserted into the spindle.</p>	 <p>The number displayed in the toolbar icon indicates which tool is in the spindle. You can select a different tool to be inserted into the spindle</p>

5.3.1.4. Outputs Toolbar

The Outputs toolbar is an active toolbar. It provides switches to supply power to the spindle, change spindle direction, power for the accessory outputs, and to the coolant outlet on the right side of the ProMill 8000. Switches for Robotic outputs 1 through 4 are also provided. Power is ON when the buttons are depressed.









Info Table: Outputs Toolbar		
Icon	Name	Function
	Spindle Output	Turns the spindle on/off.
	Spindle Direction	Reverses spindle direction when depressed, only select when spindle is stopped
	Coolant	Turns coolant on or off.
	Shield Opener	Opens and closes the Shield
	Output 1 to Output 4	Clicking a numbered Output button provides 24V power to the output of that number on the right side of the machine.

5.3.1.5. Inputs Toolbar

The Inputs Toolbar is an inactive toolbar. It provides information only on the state of the Emergency Stop, the doors, the automatic safety shield (optional), and the limit switches. Indicators for robotic inputs 1, 2, 3, and 4 are also provided. An input is active (on) when the button is depressed.



Info Table: Inputs Toolbar		
Icon	Name	Function
	E-Stop	Indicates when the Emergency Stop is pressed.
	Door	Indicates that the doors are open.
	Shield Open	Indicates that the shield is open.
	Shield Closed	Indicates that the shield is closed.
	Negative Limit	Indicates when the negative X-axis proximity switch is on.
	Positive Limit	Indicates when the positive X-axis proximity switch is on.
	Robot Inputs 1 to 4	Indicates when an input is received at one of the four robot input ports.

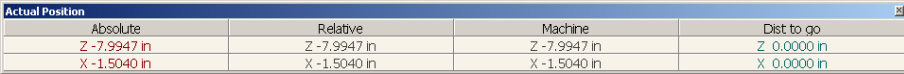
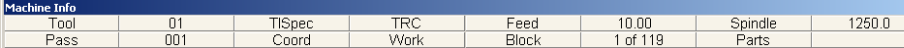

5.3.2. Information Areas

This section presents the following information:

Section Contents: Information Areas		
Item	Section	Page
Status Bar 	5.3.2.1	54
Actual Position Panel 	5.3.2.2	54
Machine Info Panel 	5.3.2.3	55

5.3.2.1. Status Bar

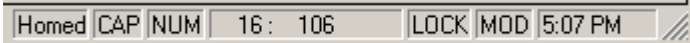
The Status bar provides status information on the NC program in progress, the software, and the computer.

Info Table: Status Bar	
Left Side	Provides information about the currently selected function. 
FR	Shows the current feed rate.
SS	Shows the current spindle speed.
SL	Shows spindle load.
AP	Shows relative air pressure.
QS	Shows queue status.
Right Side	Provides various status information.  When the indicator is dimmed, the function is in the off condition. For example:  The program has been modified The program has not been modified.
Homed	The milling center is homed / not homed.
CAP	The Caps Lock key is activated / not activated.
NUM	The Num Lock key is activated / not activated.
(16: 106)	The current line and total number of lines in the program.
LOCK	The current NC part program is locked for editing / not locked for editing.
MOD	The current NC part program has been modified / has not been modified.
(5:07 PM)	The current time according to your computer.

5.3.2.2. Actual Position Panel

The Actual Position panel provides information on the current X, Y, and Z coordinates of the tool position. The units of measure in the Actual Position window are determined by the Units command under the Set-up menu.

Actual Position 			
Absolute	Relative	Machine	Dist to go
X -1.1044 in	X -1.1044 in	X -1.1044 in	X 0.0000 in
Y -1.0428 in	Y -1.0428 in	Y -1.0428 in	Y 0.0000 in
Z -1.6530 in	Z -1.6530 in	Z -1.6530 in	Z 0.0000 in

The Actual Position Window displays the current position of the machining tool in four coordinate systems.

Info Table: Absolute Position Panel	
Column	Displays
Absolute	The position of the tool in the current coordinate system.
Relative	The position of the tool relative to the Work coordinates.
Machine	The position of the tool relative to the machine's home position.
Dist to go	The distance remaining until the end of the current line of code (if a program or NC code is currently running).

Right clicking on the Actual Position window provides other options such as Set Position, Zero position, Goto and Hide.

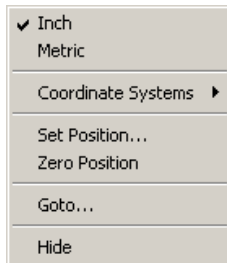

5.3.2.3. Machine Info Panel

The Machine Info panel provides information on the current tool, tool reference point, feed rate, spindle speed, number of passes made, coordinate system in use, as well as the current block and total number of blocks in the program.

Machine Info							
Tool	01	TDiam	0.125	Feed	60.00	Spindle	2500.0
Pass	001	Coord	Work	Block	1 of 1	Parts	

When a part program is running, the Machine Info panel also provides a dynamic display of the elapsed machining time and highlights the block of code that is currently being executed.

Machine Info							
Tool	01	TDiam	0.125	Feed	10.00	Spindle	2500.0
Pass	001	Coord	Work	Block	5 of 27	Parts	
Part Time 00:03							
4 N3 ;T1 IS A 1/8" END MILL							
5 N4 G05							
6 N5 M06 T01							

The Machine Info panel includes the following information.

Info Table: Machine Info Panel		
Tool	02	Shows the tool number currently in use.
TDiam	0.125	Displays the diameter of the current tool
Feed	20.00	Shows the current feed rate, in inches/min or mm/min.
Spindle	1250.0	Shows the current spindle speed, in RPM.
Pass	001	Shows how many times the program has been run.

Coord	Work	Current work coordinates.
Block	1 of 119	Shows the program line number currently being executed, and the total number of program lines.
Parts		Counts how many parts have been made.

5.3.3. Program Editing Window

Whenever you open an NC part program file, it is displayed in its own Edit window. You can have multiple Edit windows open at a time.

A sample Edit window is shown below.

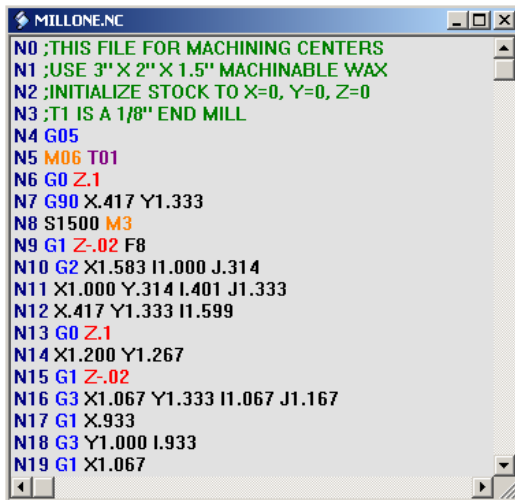

By default, the Edit window is locked, meaning that you cannot edit the program within it. A locked Edit window has a grey background, and an unlocked Edit window has a white background.

Follow this procedure to unlock an NC program for editing.

Procedure: Unlocking an NC Program for Editing

1. Click **Edit** | **Lock** in the Main Menu to remove the lock. Alternatively, press **Ctrl-L** on your keyboard.

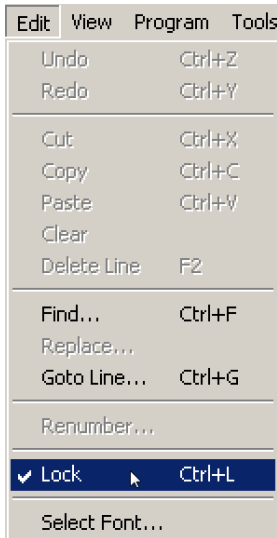

The Edit window's background color changes to white. Editing is now enabled.

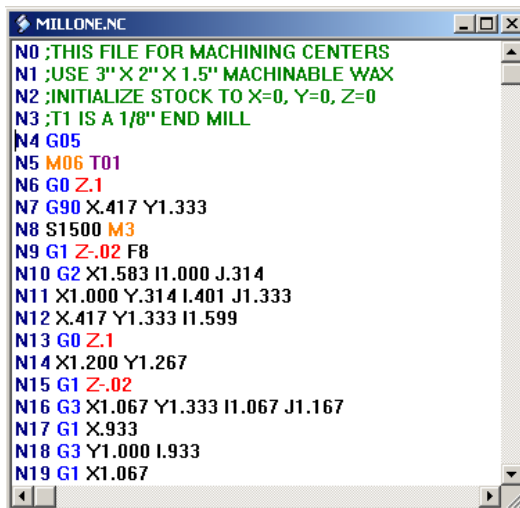

5.3.4. Control Panels

The ProMill 8000 does not have any controls on the machine itself, other than the Emergency Stop and door release buttons. All control operations are performed from the control software.

There are two control panels:

- The Jog Control panel allows you to move the tool in the X, Y and Z directions, and to control the speed and distance of that motion.
- The Operator panel allows you to run programs, control how programs run, and control the feed rate, and spindle speed overrides.

This section presents the following information:





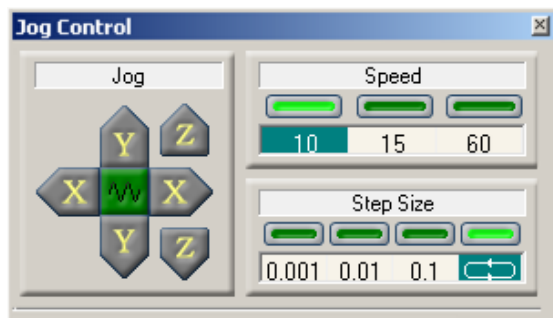

Section Contents: Control Panels		
Section	Name	Page
5.3.4.1	The Jog Control Panel	58
5.3.4.2	The Operator Panel	60

5.3.4.1. The Jog Control Panel

The Jog Control panel allows you to move the tool in the X, Y and Z directions, and to control the speed and distance of that motion.

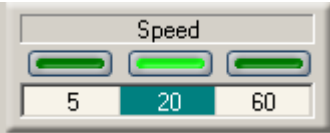
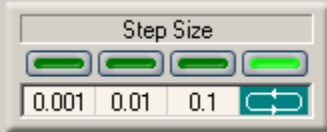
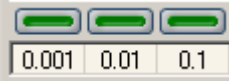

The controls on the Jog Panel are explained below.





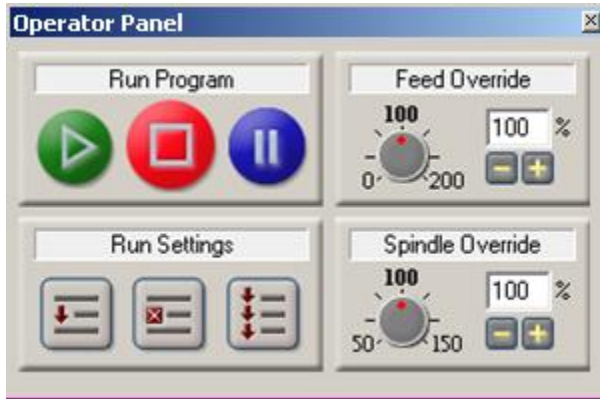

Info Table: Jog Control Panel	
	<p>Pressing the X, Y and Z buttons moves the tool in the X, Y and Z directions, positively or negatively.</p> <p>You can also use the arrow buttons on your keyboard, when the  button is active.</p> <p>The X, Y and Z controls are not displayed when the handwheel accessory is in use.</p>
 	<p>Click  to allow the arrow keys on the keyboard to control jog motion. Unclick to prevent the arrow keys from controlling jog motion.</p> <p>This button is automatically activated after clicking one of the X, Y or Z buttons.</p> <p>With a handwheel connected:</p> <ol style="list-style-type: none"> 1. Click on the green button to activate the handwheel. The arrow buttons will disappear. 2. Click again to deactivate the handwheel and restore the arrow buttons. 3. To deactivate the jog controls, click anywhere in the control software window other than the jog panel.
	<p>The axis will move at the speed selected in the Speed area. Units are in inches/min, or mm/min.</p> <p>You can change these preset speeds in the Settings window, accessed by clicking Setup Jog Settings in the Main Menu.</p>
	 <p>Sets the step size, in inches or mm.</p> <p>If one of these buttons is activated, each time you press an X, Y or Z button the axis will make a single motion determined by the step size.</p> <p>You can change these preset step sizes in the Settings window, accessed by clicking Setup Jog Settings in the Main Menu.</p>  <p>Sets the jog motion to continuous. If this button is activated, holding down an X, Y or Z button will cause the axis to move continuously at the speed set in the Speed area.</p>

5.3.4.2. The Operator Panel

The Operator panel allows you to run programs, control how programs run, and control the feed rate and spindle speed overrides.



The controls on the Operator Panel are explained below.

Info Table: Operator Panel	
	Runs the program, and recommences program after a pause.
	Halts the currently running NC part program.
	Pauses the currently running program immediately, even if the current block in the NC program has not been fully executed. The spindle continues spinning. The program will continue from the point at which it stopped once the operator resumes operation.
	Sets the feed rate override. The actual feed rate while milling will be calculated as the feed rate specified in the NC program multiplied by the percentage specified here.
	Sets the spindle speed override. The actual spindle speed while milling will be calculated as the spindle speed specified in the NC program multiplied by the percentage specified here.
	Optional Skip Allows you to execute or ignore any optional skips (M00) you have embedded in the NC program.
	Optional Stop Allows you to execute or ignore any optional stops (M01) you have embedded in the NC program.

	<p>Single Step</p> <p>Causes the NC program to pause after each block is executed. This allows you to check each step of the cutting operation.</p>
---	--

5.4. HOMING

The machine's Home position is a predefined position. The milling center uses this point as a reference for all machine coordinate movements. This allows you to use the Soft Limits and Coordinate Systems commands (under the Setup Menu) to move the milling center consistently to the same location.

Follow this procedure to home the machine.

Procedure: Homing

1. Either:
 - Click **Setup | Set/Check Home** in the Main Menu, or



The screenshot shows a menu with the following items: On-Line, Simulation (checked), Set Position..., Zero Position (Ctrl+Shift+Z), Jog Settings..., Run Settings... (Ctrl+R), Verify Settings..., Set/Check Home... (Ctrl+H), and Goto Position... (F8). The 'Set/Check Home...' option is highlighted in blue.
 - Press **Ctrl-H** on your keyboard, or
 - Click the Home button  in the Standard Toolbar.

The Machine Home / Reference Point window is displayed.

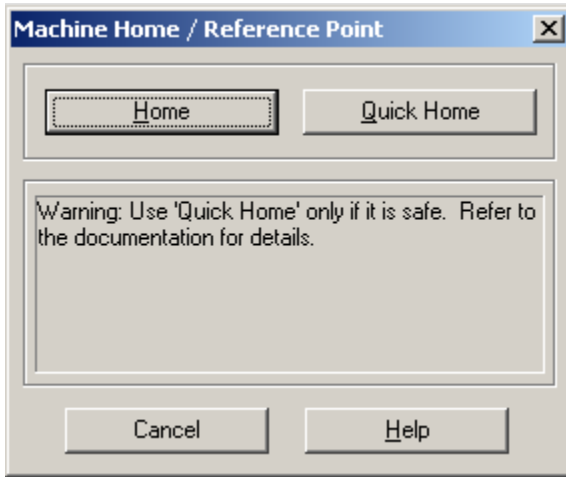

2. Click:
 - **Home** to send the machine to the home position at regular speed (recommended).
 - **Quick Home** to send the tool to the home position at a rapid speed. Use this option only if you are sure that doing so is safe.

The machine will move to its home position.

5.5. OPENING AN NC FILE

The control software allows NC files to be saved and then opened again at a later time. In addition, the control software is supplied with a number of sample NC files.

Follow this procedure to open a sample NC file.

Procedure: Opening a Sample NC File

1. Launch CNCBase/Motion. See 5.1 Launching the Control Software, pg. 42.
2. Click **File | Open** in the Main Menu.

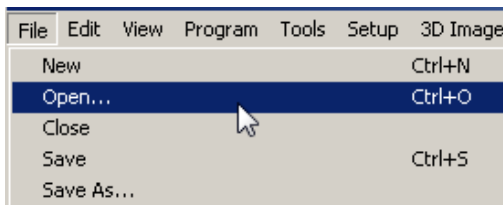

The Open window is displayed.

3. Select the program and click **Open**.

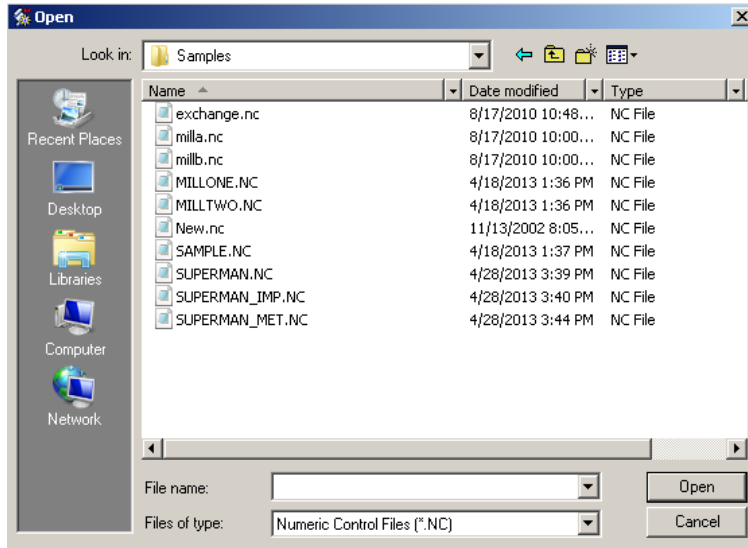

The NC program is displayed.



5.6. VERIFYING AN NC PROGRAM

Tool path verification allows you to check for programming errors before actually running the part program on the milling center. The Verify Window displays a 2D simulation of your part program.

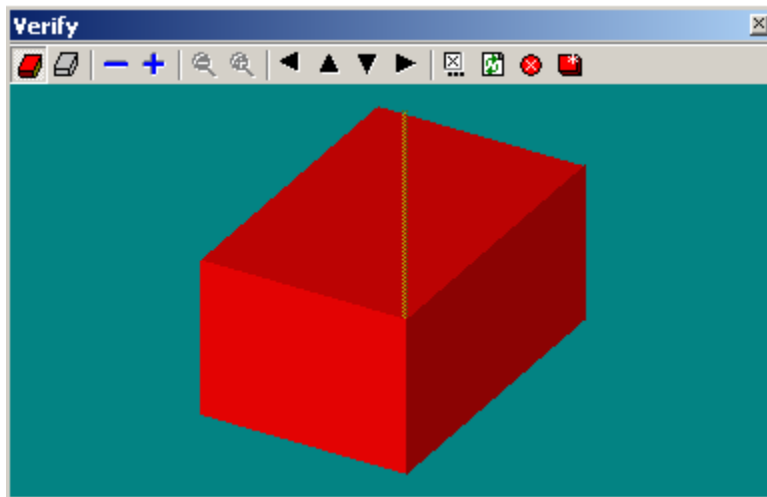

This section presents the following information:

Section Contents: Verify Window		
Section	Name	Page
5.6.1	Launching Verification	65
5.6.2	Modifying Run Settings	67
5.6.3	Configuring Verify Settings	68
5.6.4	Using the Verify Window Controls	70

5.6.1. Launching Verification

Follow this procedure to launch verification.

Procedure: Launching Verification

1. Either click the Verify icon  on the Standard Toolbar, or click **Program | Verify** on the Main **Menu**, or press **F6** on your keyboard. .

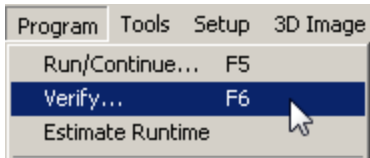

The Verify Program window is displayed.

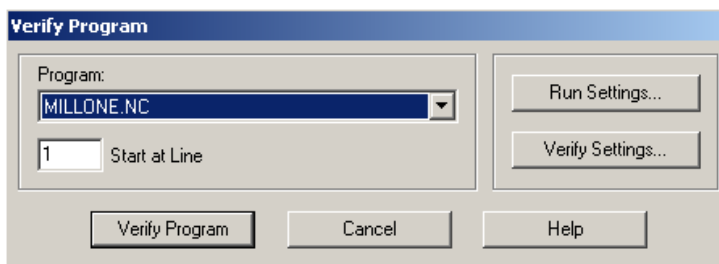

2. Click:

- **Verify Program** to commence verification in the Verify window.
- **Run Settings** to open the Run Settings window. The settings here specify how the program will run. See 5.6.2 Modifying Run Settings, pg. 67.

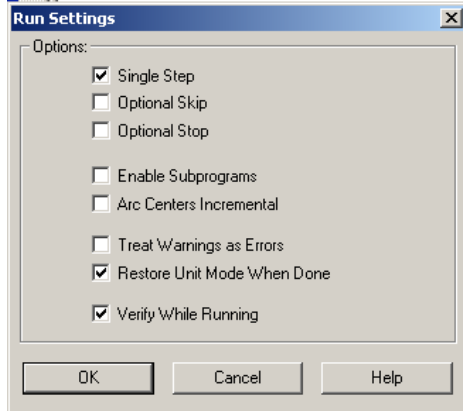

- **Verify Settings** to open the Verify Settings window. The settings here specify how the verification is displayed. See 5.6.3 Configuring Verify Settings, pg. 68.

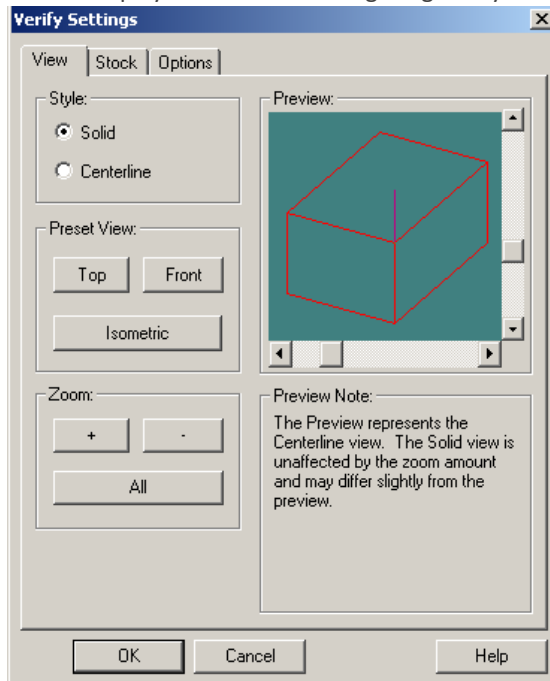

5.6.2. Modifying Run Settings

The settings in the Run Settings window specify how the program will run.

The Run Settings window is accessed by clicking **Run Settings** on the Verify Program window.

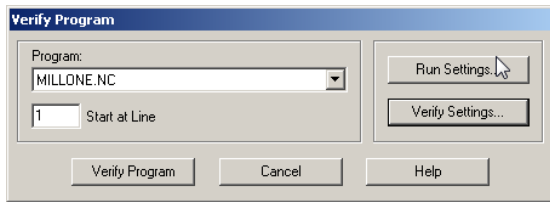

The settings available in this window are described below.

Info Table: Run Settings Window	
Single Step	Allows you to run the program one line at a time, pausing after each line is executed. (Click the Resume button  to continue program operation.)
Optional Skip	Allows you to execute or ignore any optional skips (M00) you have embedded in the NC program.
Optional Stop	Allows you to execute or ignore any optional stops (M01) you have embedded in the NC program.
Enable Subprograms	Must be checked if the program uses subprograms. If this option is disabled, M98 (Call to subprogram) commands generate an error.
Arc Centers Incremental	Specifies the Fanuc mode as the default mode for programming arc centers, in which arc centers are always incremental. When this box is unchecked, the default mode is EIA-274, in which arc centers follow the general programming mode: absolute when the mode is absolute, and incremental when the mode is incremental. To override the default, place the Incremental Arc Centers (%) or Absolute Arc Centers (\$) code in the first line of the NC file.
Treat Warnings as Errors	When this item is checked, any warning will halt the program, resulting in a program stop. When motion is stopped, all outputs are turned off. This command is used for special applications, such as laser welding, where you do not want any unexpected pauses in the program execution.
Restore Unit Mode When Done	Restores the original unit mode (inches or metric) regardless of the units specified in the current NC program. Check this box if you normally work in one unit mode (inch or metric) but would like to run a program in another mode without disrupting your default settings.
Verify While Running	When this box is checked, the Verify window will display the program verification while the program is running.

5.6.3. Configuring Verify Settings

The settings in the Verify Settings window specify how the verification is displayed

The Verify Settings window is accessed by clicking **Verify Settings** on the Verify Program window.

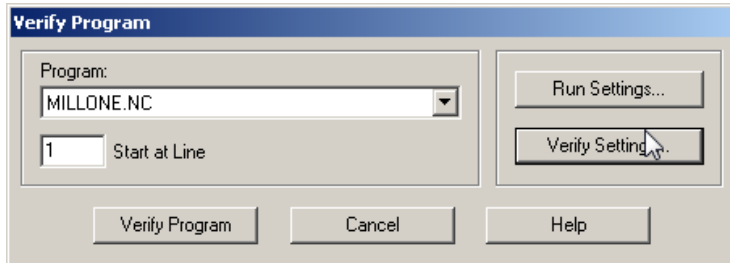

The Verify Settings window consists of three tabs.

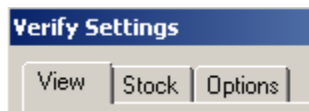

The settings available in this window are described below, arranged by tab.

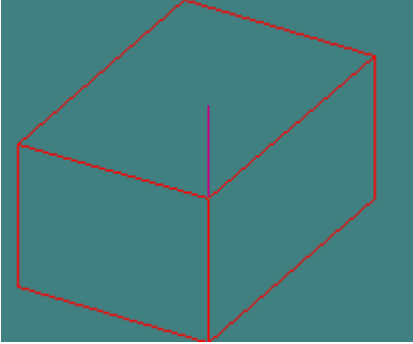
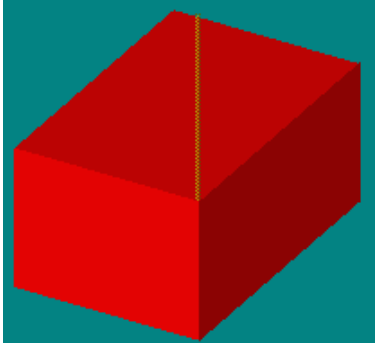
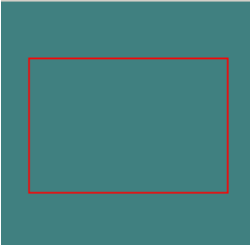
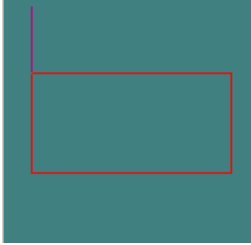
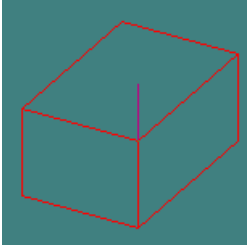
Info Table: Verify Settings Window	
View Tab	
<p>Style:</p> <p><input checked="" type="radio"/> Solid</p> <p><input type="radio"/> Centerline</p>	<p>Select whether the workpiece should be displayed in wireframe or solid view.</p> <div style="display: flex; justify-content: space-around;">   </div> <p style="display: flex; justify-content: space-around;"> Wireframe Solid </p>
<p>Preset View:</p> <p><input type="button" value="Top"/> <input type="button" value="Front"/></p> <p><input type="button" value="Isometric"/></p>	<p>Select whether the workpiece should be shown in top, front, or solid view.</p> <div style="display: flex; justify-content: space-around;">    </div> <p style="display: flex; justify-content: space-around;"> Top Front Isometric </p>

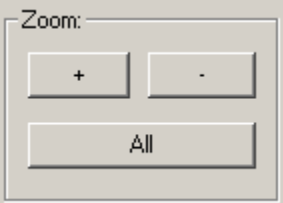
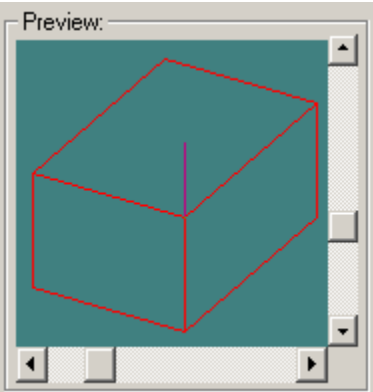
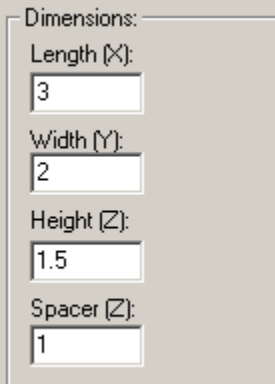
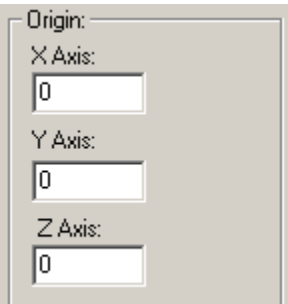









	<p>Use the Zoom controls to magnify (+), zoom out (-), or view the entire workpiece (All).</p>
	<p>All changes are reflected in the Preview window.</p>
<p>Stock Tab</p>	
	<p>Specifies the length, width, and height of the stock to be used. Spacer specifies the height of the spacer placed beneath the workpiece.</p>
	<p>Sets the stock origin relative to the front left corner of the stock.</p>

<p>Initial Tool Position:</p> <p>X: <input type="text" value="0"/></p> <p>Y: <input type="text" value="0"/></p> <p>Z: <input type="text" value="0"/></p>	<p>Specifies the coordinates from which the tool must start motion.</p>
--	---

5.6.4. Using the Verify Window Controls

The buttons on the toolbar inside the Verify window provide quick access to the display settings.



Info Table: Verify Window Controls	
	Displays the workpiece in solid view.
	Displays the workpiece in wireframe view.
	Speeds up/slow down the verification process.
	Zooms in/out.
	Repositions the view.
	Opens the Verify Settings window.
	Replays the verification process.
	Stops the verification process.
	Centers the view.
	Resets the workpiece in the Verification window.

5.7. RUNNING AN NC PROGRAM

This section provides instructions on how to run an NC program.



Safety

Before running the program:

1. Close the safety door.
2. Wear safety glasses.
3. Review all other safety precautions in 1 Safety Guidelines, pg. 1.
4. Be prepared to press the Emergency Stop button on the machine, if anything goes wrong.



Product Care

Before running an NC program for the first time, you are advised to follow the tutorial presented in chapter 7 Tutorial: Milling a Sample Part, pg. 77.

Follow this procedure to run the program:

Procedure: Running the Program

1. Follow the safety instructions presented above.
2. Click **Program | Run/Continue** in the Main Menu.

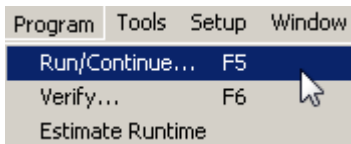

The Run Program window is displayed.

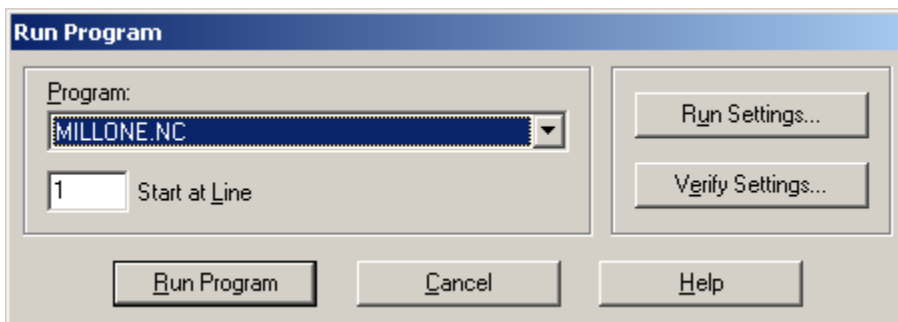

3. Ensure that *Start at Line* is set to line 1.
4. Click:
 - **Run Program** to begin running your program.
 - **Run Settings** to open the Run Settings window. The settings here specify how the program will run. See 5.6.2 Modifying Run Settings, pg. 67.
5. Once the program has ended, press the Emergency stop button, open the safety door, and remove the finished part.

5.8. ACCESSING HELP

The comprehensive online help can be accessed in the following ways from within the software.

Info Table: Accessing Help

Press **F1** on your keyboard.

Click **Help** in the main menu, and then select **Help**.

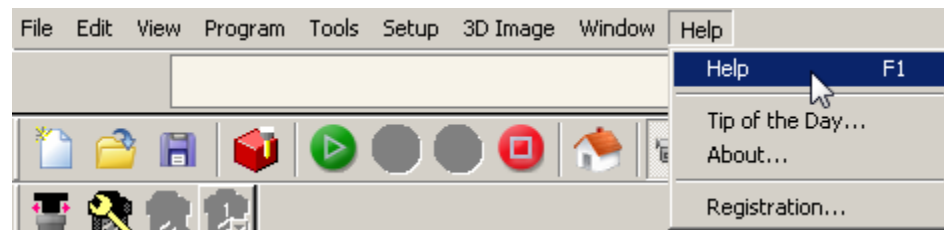

Click the **Help** button located on many of the windows to open the relevant Help page.

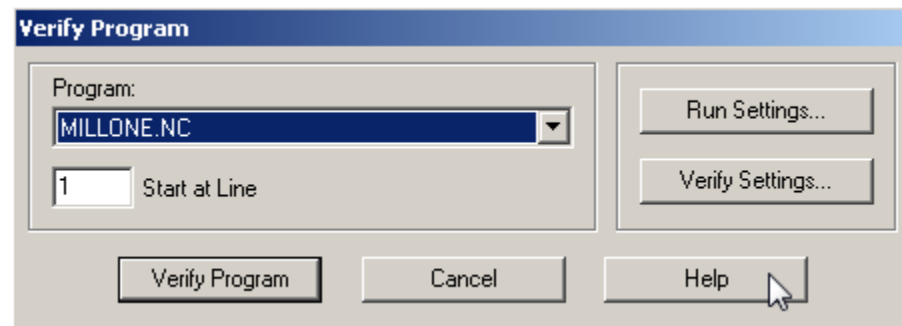

6. Installing a Tool

The ProMill 8000 comes equipped with a pneumatic drawbar which allows for quick and accurate manual tool changes. An automatic tool changer (ATC) is available as an optional accessory.

This section provides instructions for manually changing a tool. Instructions for setting up tools in a tool changer are provided in the documentation supplied with that product.



Safety

Milling tools are extremely sharp. To avoid cutting yourself, it is best to handle them from the shank, with gloves or a shop rag. Never touch the teeth with your hands!

The procedure for mounting a tool consists of the following steps:

Procedure Outline: Mounting a Tool			
No.	Description	Section	Page
1	Remove the tool holder from the spindle.	6.1	74
2	Insert the tool into the tool holder.	6.2	74
3	Insert the tool holder into the spindle.	6.3	75

6.1. REMOVING THE TOOL HOLDER FROM THE SPINDLE

Follow this procedure to remove the tool holder from the spindle.

Procedure: Removing the Tool Holder from the Spindle

1. Ensure that the CNC machine is connected to the computer, and that CNCBase or CNCMotion is running on the computer.
2. Ensure that Emergency Stop button is released.
3. Turn on the power switch.
4. Ensure that the safety shield is open.
5. While holding the tool by the bottom of the tool holder, press the green drawbar button on the spindle.
6. Pull the tool holder downward, removing it from the spindle.

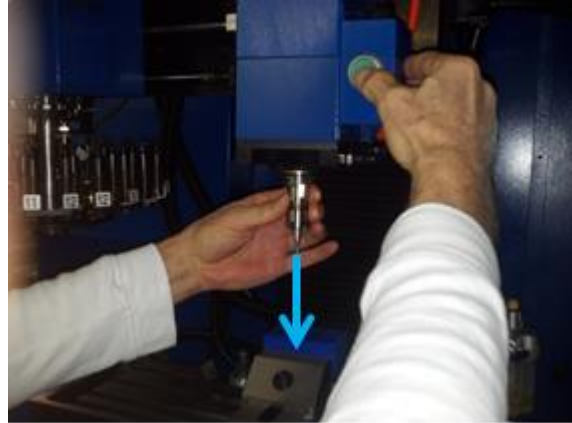

6.2. INSERTING THE TOOL INTO THE TOOL HOLDER

Follow this procedure to insert a milling tool into the tool holder.

Procedure: Inserting the Tool into the Tool Holder

1. Loosen the tool holder nut from the tool holder by turning it counter-clockwise.

If the tool holder nut separates from the tool holder completely, screw it back in loosely.
2. If the tool holder currently holds a tool, remove it now.
3. Slide the new tool into the collet.



4. Tighten using the tool holder nut wrench.



5. Further tighten the assembly using the appropriate crescent wrench and the tool holder nut wrench.



6.3. INSERTING THE TOOL HOLDER INTO THE SPINDLE

Follow this procedure to insert the tool holder into the spindle.

Procedure: Inserting the Tool Holder into the Spindle

1. Ensure that Emergency Stop button is released.
2. Turn on the power switch.
3. Ensure that the safety shield is open.
4. While holding the tool by the bottom of the tool holder, press the green drawbar button on the spindle and insert the tool holder into the spindle, then release the green drawbar button. The tool should be sucked into the spindle.

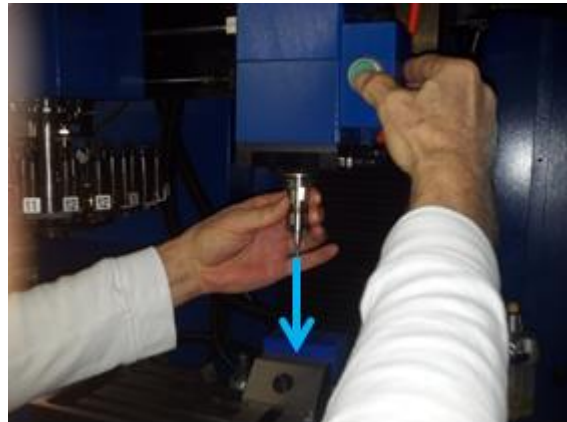

5. Ensure that the tool is installed correctly by holding the tool by the flange of the tool holder and turning the tool and spindle. Ensure that the tool and spindle spin together as one unit.



7. Tutorial: Milling a Sample Part

This section provides detailed instructions for milling a simple sample part, covering the entire process from NC program verification through milling a complete part on the ProMill 8000. The tutorial will follow this procedure.

Procedure Outline: Tutorial			
No.	Step	Section	Page
1	Review safety procedures.	7.1	78
2	Prepare tools and materials required.	7.2	78
3	Open the sample NC file.	7.3	78
4	Determine the stock size required to mill the part.	7.4	79
5	Adjust the verification simulation settings.	7.5	80
6	Define the tool to be used.	7.6	84
7	Verify the program.	7.7	86
8	Turn on and home the machine.	7.8	87
9	Mount the workpiece.	7.9	88
10	Set the X, Y, and Z coordinates of the top, front, left corner of the workpiece to zero.	7.10	88
11	Perform a dry run.	7.11	93
12	Run the program.	7.12	94

7.1. REVIEWING SAFETY PROCEDURES

Like any other power tool, the ProMill Milling Center is a potentially dangerous machine if operated in a careless manner. The importance of safely operating the ProMill Milling Center, including the need for protection against personal injury and the prevention of damage to the equipment, cannot be stressed enough.



Safety

Ensure that you are familiar with all safety guidelines in 1 Safety Guidelines, pg. 1, before continuing.

7.2. PREPARING TOOLS AND MATERIALS

For this tutorial you will require the following:

Tools and Materials List: Tutorial

One 3x2x1.5" piece of aluminum, Delrin, or wax

7.3. OPENING THE SAMPLE NC FILE

In this step you will launch CNCBase/Motion and will open a sample NC file.

Follow this procedure to open a sample NC file.

Procedure: Opening a Sample NC File

1. Launch CNCBase/Motion. See 5.1 Launching the Control Software, pg. 42.
2. Click **File | Open** in the Main Menu.

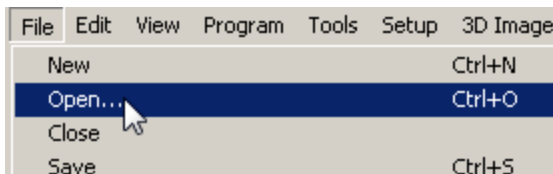

The Open window is displayed.

3. Select *SUPERMAN_IMP* and click **Open**.

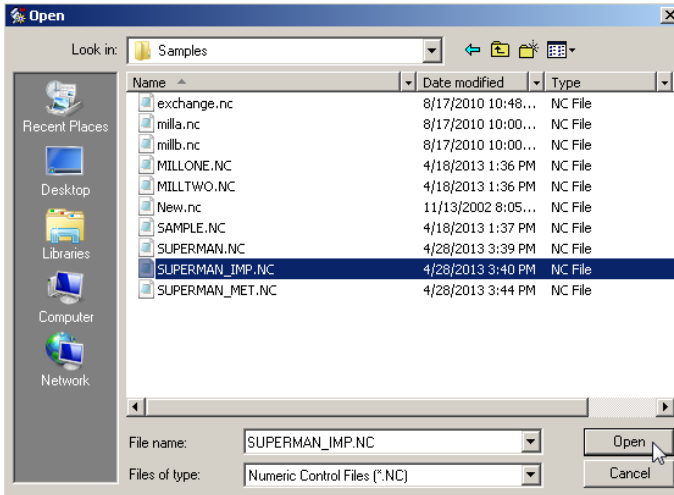

The NC program is displayed. The grey background indicates that the program is currently locked for editing.

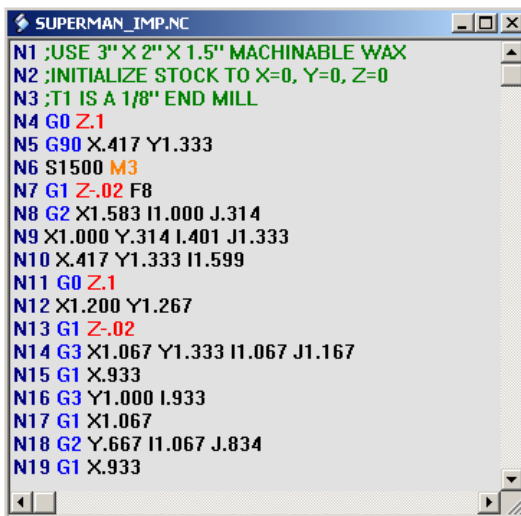

7.4. DETERMINING THE STOCK SIZE

For the Verify window to accurately simulate the NC program, you will have to specify the stock size before running the verification.

Milling stock is defined by three variables:

- Its length (which extends in the X, or horizontal, direction)
- Its width (which extends in the Y direction, from the front of the machine towards the back.)
- Its height (which extends in the Z, or vertical direction)

In this case, the required dimensions are displayed within the NC program, as shown below.

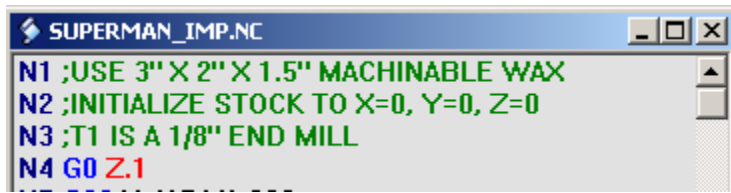

```

SUPERMAN_IMP.NC
N1 ;USE 3" X 2" X 1.5" MACHINABLE WAX
N2 ;INITIALIZE STOCK TO X=0, Y=0, Z=0
N3 ;T1 IS A 1/8" END MILL
N4 G0 Z.1
  
```

7.5. CONFIGURING THE VERIFY SETTINGS

Before you run the verification simulation, you must adjust the verification settings so that the verification simulation will accurately simulate the tool-workpiece combination you will be using.

This section provides instructions for configuring the Verify Settings.

Outline: Configuring Verify Settings			
No.	Step	Section	Page
1	Open the Verify Settings Window.	7.5.1	81
2	Adjust the view settings.	7.5.2	82
3	Specify the size of the stock and location of the origin from which measurements are taken. Set the position from which the tool must start.	7.5.3	82

7.5.1. Accessing the Verify Settings Window

Follow this procedure to access the Verify Settings window.

Procedure: Accessing the Verify Settings Window

1. Check to see if the Verify window, shown below, is currently displayed on the CNCBase/Motion screen.

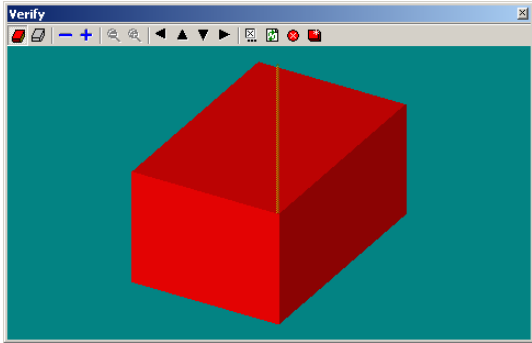

If the Verify window is not displayed, click **View**, and click **Verify Window** to open it.

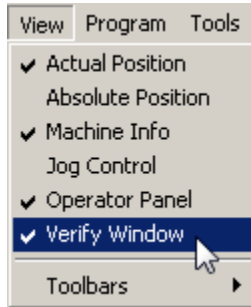

2. Click the Verify Settings  button in the Verify window.



The Verify Settings window is displayed.

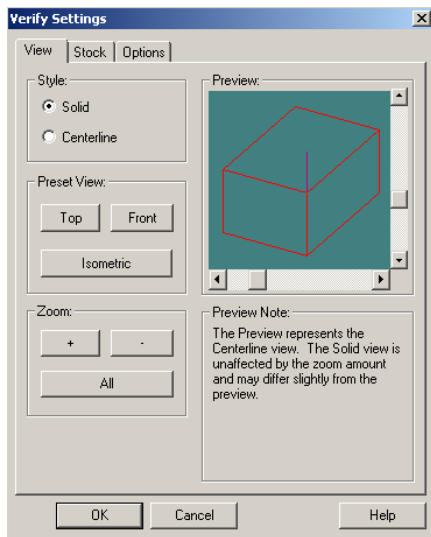

7.5.2. Adjusting the View Settings

Follow this procedure to adjust the view settings.

Procedure: Adjusting the View Settings

1. Click the **View** tab. This tab is used to specify the appearance of the Verify animation.

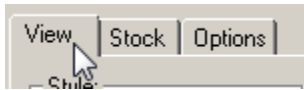

2. Make all required settings. See 5.6.3 Configuring Verify Settings, pg. 68.

7.5.3. Setting the Stock Dimensions and Origin

You will next specify the length, width and breadth of the stock, and then set the origin of the axes to be referenced.

Follow this procedure to set stock dimensions and origins.

Procedure: Setting Stock Dimensions and Origins

1. Select the **Stock** tab.
2. Enter the stock dimensions for the superman_imp.nc part program. The stock dimensions define the dimensions of the stock outside the chuck.
 - $X = 3.0''$
 - $Y = 2''$
 - $Z = 1.5''$
 - We will use a spacer of $1''$.

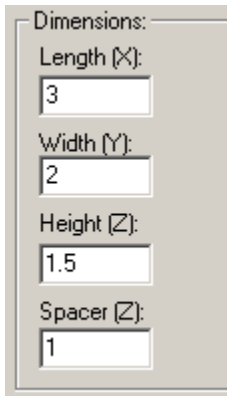

The screenshot shows a dialog box titled "Dimensions:" with four input fields. The "Length (X):" field contains the value "3", the "Width (Y):" field contains "2", the "Height (Z):" field contains "1.5", and the "Spacer (Z):" field contains "1".

3. Set the Origin of Stock to
 - $X = 0''$
 - $Y = 0''$
 - $Z = 0''$

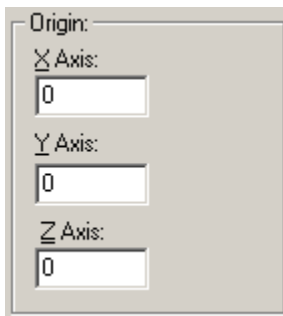

The screenshot shows a dialog box titled "Origin:" with three input fields. The "X Axis:" field contains the value "0", the "Y Axis:" field contains "0", and the "Z Axis:" field contains "0".

4. Set the initial tool position to:

- $X = 0''$
- $Y = 0''$
- $Z = 0.5''$

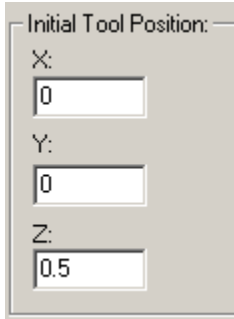

The settings will ensure that the tool starts 0.5" above the origin corner.

5. Select **OK**.

The window closes and your changes are applied to the workpiece in the Verify Window.

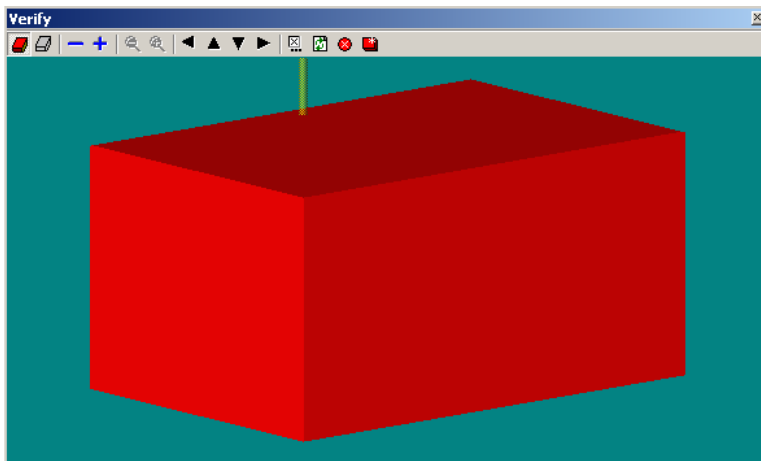

7.6. DEFINING THE TOOL

You will use an eighth inch end mill to mill this part. You will use the parameters for this particular tool for the tool path verification as well.

You will first define the tool and will then specify that tool as the tool to be used during verification.

Follow the procedure below to define the tool for verification.

Procedure: Defining the Tool

1. Click **Tools | Setup Library** in the Main Menu.
 The Setup Tool Library window is displayed.
2. Select **Tool 01**, a 0.125" endmill.
3. Check that the settings for Tool 01 are as shown below. If they are not, modify the settings to match the settings shown.

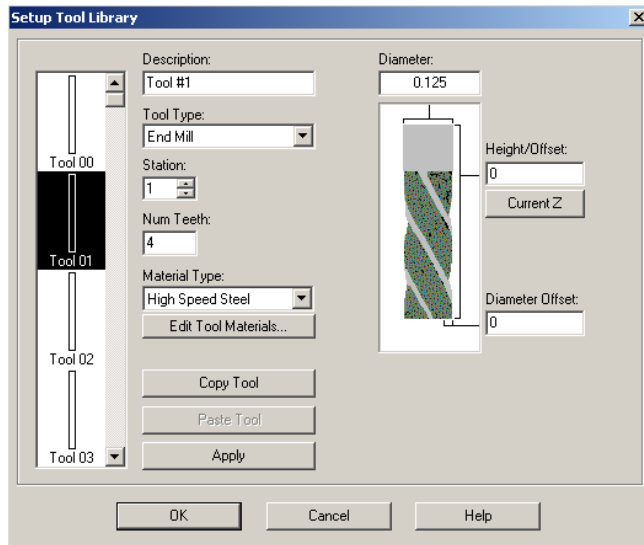

4. Click **OK** to close the Setup Tool Library.
5. Click **Tools | Select Tool** in the Main Menu. The Select Tool for Use window is displayed.
6. Select the tool you have just defined, T01, from the *Tool* drop-down list.

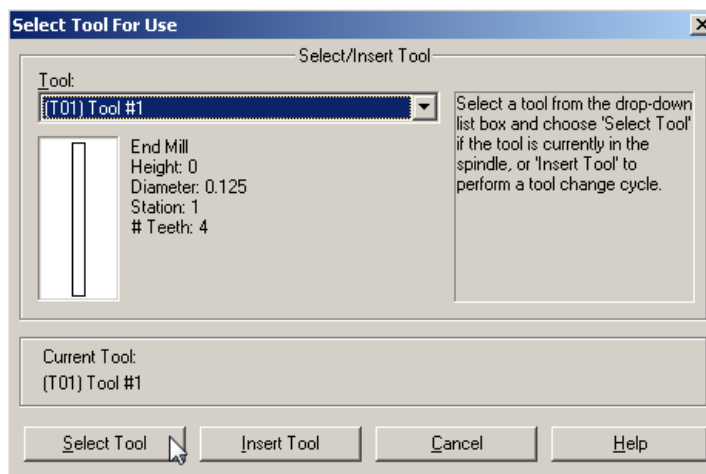

7. Click **Select Tool**.
8. Tool 01 is now selected.

7.7. VERIFYING THE PROGRAM

Tool path verification allows you to check for programming errors before actually running the part program on the Milling Center.

Follow this procedure to verify the program.

Procedure: Verifying the Program

1. Click **Program | Verify** in the Main Menu or click the Verify icon  in the Standard Toolbar.
2. Ensure that Start at Line is set to **1**. This specifies that the program should be run from the first line onward.
3. Click **Verify Program**.

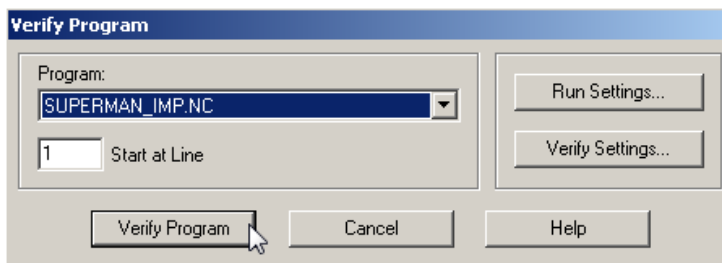

In the Verify window, the cutting tool you specified earlier is now displayed at the initial position you specified.

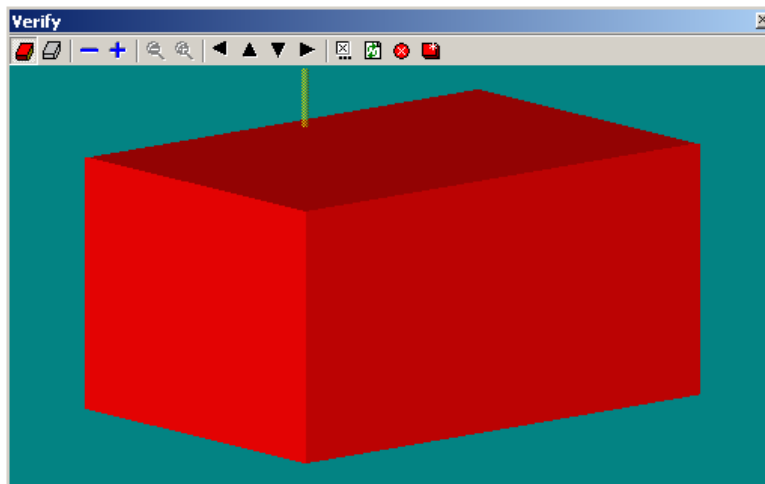

The program is verified. Upon completion the Normal Program Stop window is displayed.

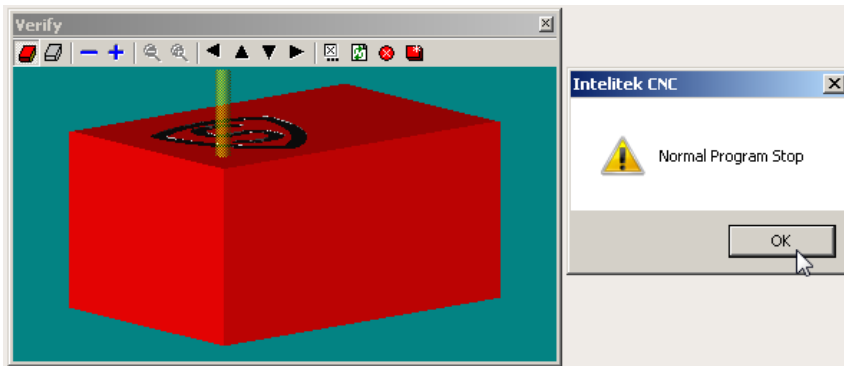

4. Click **OK**.

7.8. TURNING ON AND HOMING THE MACHINE

The Verify procedure you have just completed verified that the path the tool is to follow will almost certainly not result in any collisions with the workpiece or vise. You will now prepare to test the program on the CNC machine itself, first without the workpiece in place, and later with the workpiece in place.

First, however, the machine must be turned on and homed.

Follow this procedure to turn on and home the machine.

Procedure: Turning On and Homing the Machine

1. Review the safety precautions in 1 Safety Guidelines, pg. 1.
2. Turn on the machine using the power switch on the right side panel.
3. Click **Setup | Set/Check Home** in the main menu, or press Ctrl-H on your keyboard.

The Machine Home / Reference Point window is displayed.

4. Click **Home**.

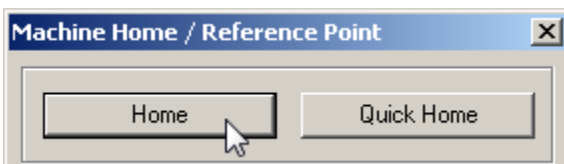

7.9. MOUNTING THE WORKPIECE

Although you will first test the program without a workpiece in place, you must initially mount the workpiece so as to be able to set up the machining axes relative to the workpiece.

Follow this procedure to mount the workpiece.

Procedure: Mounting the Workpiece

1. Ensure that your 1/8" end mill is in the spindle.
2. Use the Jog Keypad to jog the tool well above the vise.
3. Push the Emergency Stop button.
4. Open the safety door.
5. Mount the workpiece in the vise. Your workpiece should be a block 3.0" wide, 2" deep, and 1.5" tall. Use a spacer to ensure that the face of the stock is at least 1/8" above the top of the vise jaws.
6. Close the safety door.
7. Release the Emergency Stop button.

7.10. SETTING THE AXES ZERO POSITIONS

Once the workpiece is mounted in place, you must touch off the top, front, left corner of the workpiece to specify the coordinates of that point as your origin, where the X, Y, and Z axes are set to zero.

Follow this procedure to set the axes zero positions:

Procedure: Setting the Axes Zero Positions

1. Locate the Jog Control panel on your screen.

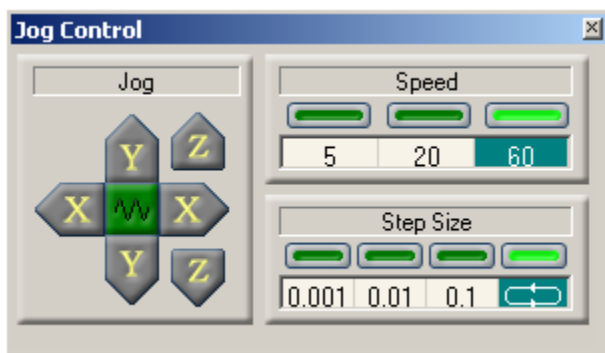

If it is not displayed, click **View | Jog Control** in the Main Menu.

2. First, you will touch off the top of the stock ($Z = 0$).
Take a small piece of paper, and place it on top of the workpiece.

3. Using the Jog Control window options, carefully jog the tool down towards the piece of paper on top of the workpiece. Stop when you are about 0.5 inches away from the paper.

Note the following:

- a. Click the arrow buttons or press the arrows keys on your keyboard to move the tool.
- b. To make the tool move continuously while one of the X, Y, or Z buttons is pressed:
 - i. Click the Continuous Jog button  in the Step Size area.
 - ii. Select the speed of motion in the Speed area.

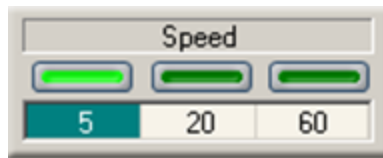

- c. To make the tool move a fixed distance each time the X, Y, or Z button is pressed, click one of the numbered step sizes in the Step Size area.

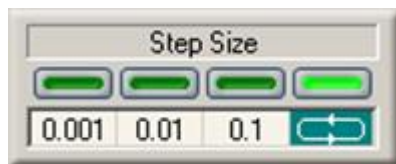

- d. To adjust the preset Speed and Step Size values:
 - i. Right-click anywhere in the Jog Control panel. A menu is displayed.
 - ii. Click **Setup**.



The Jog Settings window is displayed.

- iii. Change the settings as required and click **OK**.

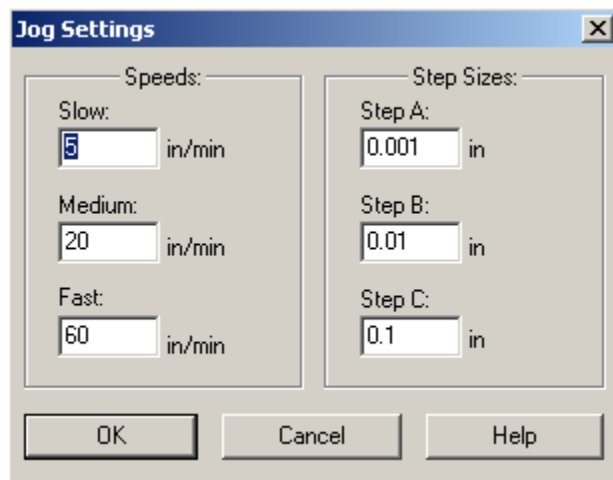

- When you are about half an inch away from the paper, switch to the slowest speed and **0.01 inch step size** and jog the tool closer to the paper. Stop when you are just above the paper.
- When you are just above the paper, switch to **0.001 inch steps**. Carefully jog the tool down until the tool tip just pinches the paper. Check this point by trying to move the paper after each step. When you can no longer move the paper, you have reached the position.
- Click **Setup | Axis to Zero** in the main menu.

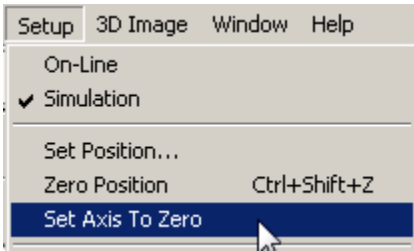

The Set Axis to Zero window is displayed.

- Select the **Z** axis.

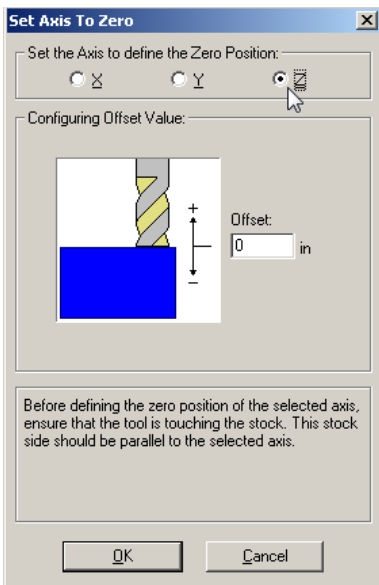

- Click **OK**. The position of the tool on the Z-axis is set to zero.
- Verify in the Machine Info window that the Z value reads **0.0000 inches**.

Actual Position		
Absolute	Relative	Machine
X -4.3240 in	X -4.3240 in	X -4.3240 in
Y -2.8230 in	Y -2.8230 in	Y -2.8230 in
Z 0.0000 in	Z 0.0000 in	Z -4.6880 in

- You will now touch off the front of the stock (Y = 0).

Jog the tool up, away from the surface of the workpiece. When you are a small distance away from the workpiece, switch to continuous movements and move the tool about 1 inch above the workpiece.

11. Hold the piece of paper against the front of the workpiece.
12. Carefully jog the tool along the Y-axis until it is about 0.5 inches in front of the workpiece.
13. Jog the tool down the Z-axis until about half the length of cut is alongside the front of the workpiece.
14. Switch to the slowest speed and **0.01 inch steps**, and jog the tool closer to the paper. Stop when you are just next to the paper.
15. When you are just next to the paper, switch to **0.001 inch steps**. Carefully jog the tool back until the cutting edge just pinches the paper. Check this point by trying to move the paper after each step. When you can no longer move the paper, you have reached the position.
16. Select **Set Position** from the Setup menu. The Set Position dialog box is displayed.
17. In the Y field, enter the coordinate of the current position on the Y-axis: **-0.0625**, and click **OK**.

Hint: Enter **-0.125/2**. The system will automatically calculate half the diameter of the tool as -0.0625.

18. Verify in the Machine Info window that the Y value reads -0.0625 inches.
19. You will now touch off the left of the stock ($X = 0$).
Switch to continuous movements and jog the tool straight up the Z-axis until the tool is 0.5 inches above the workpiece.
20. Hold the piece of paper against the left side of the workpiece.
21. Carefully jog the tool until it is about 0.5 inches to the left of the workpiece.
22. Jog the tool down until about half the length of cut is alongside the workpiece.
23. Switch to **0.01 inch steps**, and slow movements, and jog the tool closer to the paper. Stop when you are just next to the paper.
24. When you are just next to the paper, switch to **0.001 inch steps**. Carefully jog the tool back until the cutting edge just pinches the paper. Check this point by trying to move the paper after each step. When you can no longer move the paper, you have reached the position.
25. Select **Set Position** from the Setup menu. The Setup dialog box is displayed.
26. In the X field, enter the coordinate of the current position on the X-axis: **-0.0625**, and click **OK**.

Hint: Enter **-0.125/2**. The system will automatically calculate half the diameter of the tool as -0.0625.

27. Verify in the Machine Info window that the X value reads -0.0625 inches.

The machining axes are now defined.

28. Jog the tool up and away from the workpiece.

7.11. PERFORMING A DRY RUN

You will now perform a dry run. In other words, you will run the program on the machine without a workpiece in place.



The Emergency button must be pressed in before starting this procedure.

Safety

Follow this procedure to perform a dry run.

Procedure: Performing a Dry Run

1. Press the Emergency Stop button.
2. Open the safety door.
3. Remove the workpiece.
4. Close the safety door.
5. Release the Emergency Stop button.
6. Click **Program | Run/Continue** in the Main Menu.

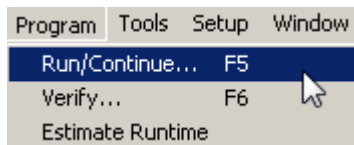

The Run Program window is displayed.

7. Click the **Run Program** button. The machine begins running the program.

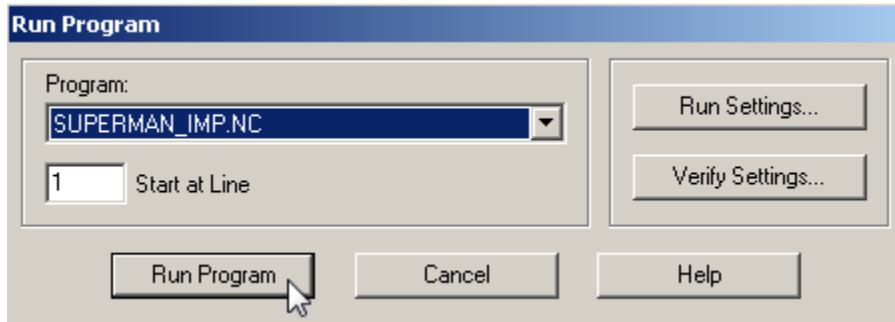

Safety

Be prepared to press the Emergency Stop button on the milling center, if it looks like a collision may occur.

As the part program runs, observe the tool motion in relation to the vise, other fixtures in the machine, and the future location of the workpiece. Look for signs of a possible tool crash and be prepared to press the Emergency Stop switch on the milling center. Edit the program as required. When you are satisfied that the tool motions are correct, you can proceed to the next step – mounting the workpiece and milling the part.

7.12. RUNNING THE PROGRAM

Now that the program has been checked in the Verify window and you have performed a dry run, the program can finally be run on an actual workpiece.



Safety

Before running the program:

1. Close the safety door.
2. Wear safety glasses.
3. Review all other safety precautions 1 Safety Guidelines, pg. 1. Be prepared to press the Emergency Stop button on the machine, if anything goes wrong.

Follow the procedure below to run the program:

Procedure: Running the Program

1. Follow the safety instructions presented above.
2. Remount the workpiece. Re-zero the axes. See 7.10 Setting the Axes Zero Positions, pg. 88.

3. Click **Program | Run/Continue** in the Main Menu.

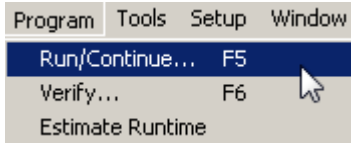

The Run Program window is displayed.

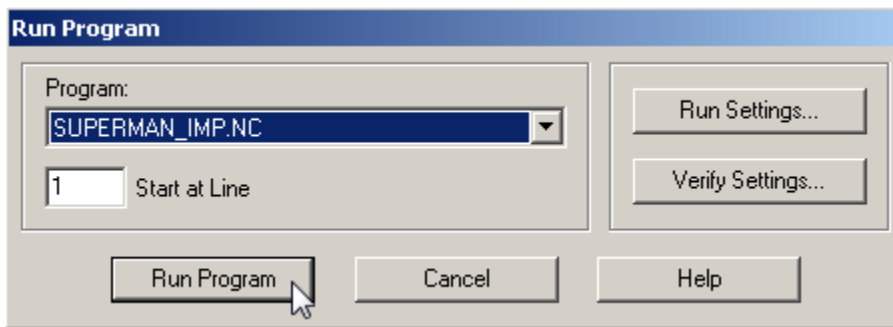

4. Ensure that Start at Line is set to line 1.
5. Click **Run Program** to begin running your program.
6. Once the program has ended, press the Emergency button, open the safety door, and remove the finished part.

8. Basic CNC Programming

This section provides a basic reference for basic CNC programming.

This section presents the following information.

Section Contents: Basic CNC Programming		
Section	Name	Page
8.1	Elements of an NC Part Program	96
8.2	General Programming Suggestions	97
8.3	Reviewing an NC Program	98
8.4	NC Codes	98

8.1. ELEMENTS OF AN NC PART PROGRAM

An NC program is composed of blocks (lines) of code. Each block contains a string of words. An NC word is a code made up of an alphabetic character (called an address character) and a number (called a parameter or value). Each line can end with a comment which is ignored while machining.

These concepts are illustrated in the graphic below.

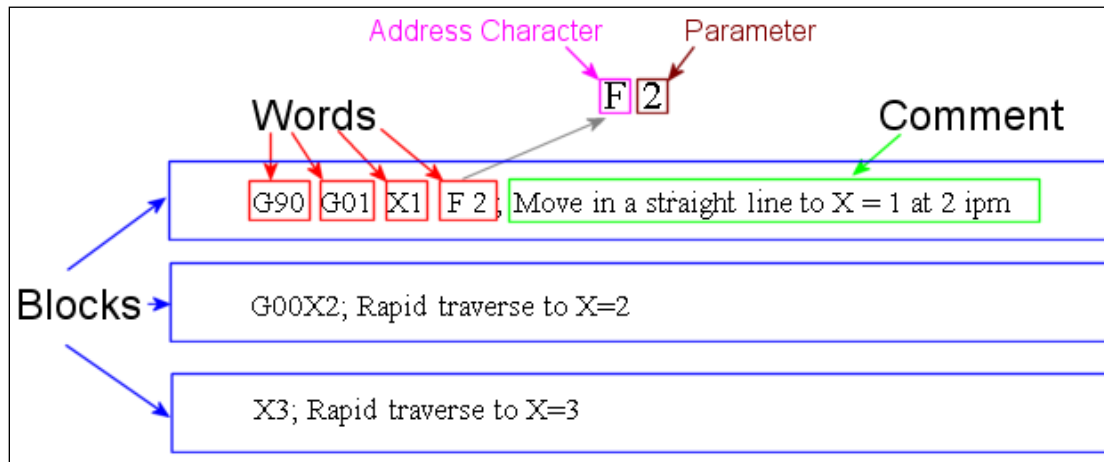

There are many categories of address characters used in NC part programs for the ProMill Milling Center (see 8.4 NC Codes, pg. 98).

Each block of NC code specifies the movement of the cutting tool on the milling center and a variety of conditions that support it.

For example, a block of NC code might read:

```
N1G90G01X.5Y.5Z1.5F1
```

The following table explains this line of code.

Example Code

```
N1G90G01X.5Z1.5F1
```

N1	This is the block sequence number for the program. Block 1 is the first block in the program.
G90	Indicates absolute coordinates are used to define tool position.
G01	Specifies linear interpolation.
X.5	Specifies the X axis destination position as 0.5".
Y.5	Specifies the Y axis destination position as 0.5".
Z1.5	Specifies the Z axis destination position as 1.5". The cutting tool will move to the absolute coordinate position (0.5, 0.5,1.5).
F1	Specifies a feed rate of 1 inch per minute, the relative velocity at which the tool is advanced along the workpiece.

8.2. GENERAL PROGRAMMING SUGGESTIONS

The following rules should be followed when writing NC part programs.

Info Table: General Programming Suggestions	
Topic	Description
Sequence of words in a block	The sequence of words (address characters and parameters) in an NC block must appear in the following order: %, \, /, N (O), G, X (U),Z (W), I, K, R, Q, L, F, M, S, T, P, ; A different order may cause unpredictable results.
Repeating words in multiple lines	In many cases, a word need not be repeated in the next block (line). The system assumes no change in codes unless a new code appears. This does not apply to the following codes: N words, I and K, G04, G05, G25, G26, G92, F used for dwell, M02, M20, M25, M26, M30, M47, M98 or M99.
Multiple G words in a single block	You can use more than one G code in a block; however, you can use only one G code from any one group in a single block.
M codes in a single block	M codes should be placed on separate blocks to avoid confusion over whether an M code is activated during or after a motion command.
Use of N words	N codes (sequence numbers) are not required in a part program; however, they can be useful in identifying a block when editing a long NC part program.
Use of O words	An O code is required to mark the beginning of a subprogram and does not have to be in sequence with the N codes.
First steps in a part program	The first portion of a part program should turn on the spindle and establish the feed rate and spindle speed.
Referencing the zero point	Part programs should reference the zero point with X0Y0Z0 at the front left corner of the work piece. This convention allows for standardization of programming.
First movement command in program	The first instruction in a part program should move the tool to the starting position. This makes restarts much easier.

Last movement command in program	The last block of a program should move the tool back to the starting position. The tool will then be in position to start cutting another part.
----------------------------------	--

8.3. REVIEWING AN NC PROGRAM

Once an NC program has been written, it must be checked carefully before the first part is machined. Errors in an NC program can cause machine damage and injury to the operator.

Follow this procedure to check an NC program.

Procedure: Reviewing an NC Program
<ol style="list-style-type: none"> 1. Double-check all program blocks against your coding sheet to locate and correct typographical errors. 2. Look for the typical coding error that places two X, Y, or Z codes in the same block. 3. Be sure that all required coordinates have been written into appropriate blocks. 4. Verify the part program to discover any program errors. 5. Run the part program without mounting stock in the milling center to see if the tool movements are logical.

8.4. NC CODES

NC codes are divided according to category. Some categories consist of one code only (single category type), while other categories include a large number of different codes (multiple category type).

This table lists all code categories. Information on all codes is presented in the sections referenced.

Info Table: G Code Categories				
Code	Function	Type of Category	Section	Page
%	Incremental Arc Centers (Fanuc)	Single	8.4.1	99
\$	Absolute Arc Centers	Single	8.4.2	99
\	Skip	Single	8.4.3	100
/	Optional skip	Single	8.4.4	100
F	Feed rate in inches per minute, with G04, the number of seconds to dwell	Single	8.4.5	100
G	Preparatory codes	Multiple	8.4.6	101
H	Input and output selection number	Single	8.4.7	116
I	Arc center, X axis dimension (circular interpolation)	Single	8.4.8	116
J	Arc center, Y axis dimension (circular interpolation)	Single	8.4.9	117
K	Arc center, Z axis dimension (circular interpolation)	Single	8.4.10	117

L	Loop counter Program cycle (repeat) counter for blocks and sub- programs, angle of arc resolution	Single	8.4.11	118
M	Miscellaneous codes	Multiple	8.4.12	120
N	Block number (user reference only)	Single	8.4.13	125
O	Subprogram starting block number	Single	8.4.14	125
P	Subprogram reference number (with M98 or M99)	Single	8.4.15	126
Q	Depth of cut. Peck depth for pecking canned cycle	Single	8.4.16	126
R	Specifies the position from which to start a drilling operation	<i>Single</i>	8.4.17	126
S	Spindle speed	Single	8.4.18	127
T	Tool selection	Single	8.4.19	127
U	Incremental X motion dimension	Single	8.4.20	127
V	Incremental Y motion dimension	Single	8.4.21	127
W	Incremental Z motion dimension	Single	8.4.22	127
X	X axis motion coordinate	Single	8.4.20	127
Y	Y axis motion coordinate	Single	8.4.21	127
Z	Z axis motion coordinate	Single	8.4.22	127
;	Comment	Single	8.4.23	127

8.4.1. % Code: Incremental Arc Center

The incremental arc center code selects the Fanuc mode of programming arc coordinates. This mode is selected for the entire NC program as well as for any chained programs.

In the Fanuc mode, arc centers are always based on incremental coordinates, regardless of whether the system is in G90 (absolute) or G91 (incremental) coordinate mode. In contrast, arc center specifications in the EIA-274 programming mode (specified by the \$ code) follow the selected coordinate mode (absolute or incremental).

The % character must stand alone on the first line of the NC program in which it appears.

The default arc center mode is defined in the Run Settings window, accessed by clicking Setup | Run Settings, in the Main Menu.

8.4.2. \$ Code: Absolute Arc Centers

The absolute arc center code selects the EIA-274 mode of programming arc coordinates. This mode is selected for the entire NC program as well as for any chained programs.

In the EIA-274 mode, arc centers are based on the selected coordinate mode: absolute (G90) or incremental (G91). In contrast, arc center specifications in Fanuc mode (specified by the % code) are always incremental, regardless of whether the system is set to absolute or incremental coordinate mode.

The \$ character must stand alone on the first line of the NC program in which it appears.

The default arc center mode is defined in the Run Settings window, accessed by clicking Setup | Run Settings, in the Main Menu.

8.4.3. \ Code: Skip

The Skip code causes the program line to be skipped when the program is run.

Place the code at the beginning of the line you wish to skip. When you run the NC program, the specified line will be skipped.

You can also use the Skip code (\) with a parameter to instruct the control software to execute the line of code every nth pass. Place the code at the beginning of the line you wish to skip. The syntax is: \n, where n is the number of passes between executions.

For example, if you want to execute a block of code every 5 passes, place \5 as the first code at the beginning of the block.

8.4.4. / Code: Optional Skip

The Optional Skip codes allow you to skip particular lines of code in your program.

Lines marked with the optional skip (/) code are skipped only when the Optional Skip parameter from the Run Settings window is checked (see 5.6.2 Modifying Run Settings, pg. 67).

To use the Optional Skip code (/), place the code at the beginning of the line you wish to skip. Select the Optional Skip option from the Run Settings window or the Operator Panel.

You can use the optional skip code with a parameter to instruct the control software to execute the line of code every nth pass. Place the code at the beginning of the line you wish to optionally skip. The syntax is: /n, where n is the number of passes between executions.

For example, if you want to execute a block of code every 5 passes, place /5 as the first code at the beginning of the block.

8.4.5. F Code: Feed Rate

The F Code is used to specify the velocity at which the tool moves (the feed rate). The feed rate is specified in inches or millimeters per minute, depending on the selected unit of measure. For example, F3 specifies a feed rate of 3 inch/min when using inch units or 3 mm/min when using metric units.

The feed rate should be set to a low value (up to 10 inch/min) for cutting operations. The feed rate chosen depends on the combination of tool size, cut depth, and material type.

The control software limits the programmed feed rate so that it doesn't exceed the maximum allowed by the milling center.

The F Code is also used to specify the number of seconds to dwell when used with the G04 code. For example, G04F5 causes the machine to dwell for five seconds. See 8.4.6.3 The Wait Group, pg. 102.

8.4.6. G Codes: Preparatory Codes

G codes take effect before a motion is specified. They specify settings such as the type of cut to be made, whether absolute or incremental dimensioning is to be used, whether to pause for operator intervention, and so on.

There are a large number of G codes, each differentiated by the number following the G. For example, G01, G90, and G71 are all different G codes.

The various G codes are divided into different groups. Multiple G codes from different groups can appear in each NC block. However, you may not place more than one G code from a group in one block.

The ProMill 8000 supports the following G code groups.

Info Table: G Code Groups			
Group	Includes Codes	Section	Page
The Interpolation Group	G00, G01, G02, G03, G101	8.4.6.1	101
The Units Group	G70, G71, G20, G21	8.4.6.2	102
The Wait Group	G04, G05, G25, 26	8.4.6.3	102
The Canned Cycle Group	G32, G72, G73, G77, G79, G80, G81, G83	8.4.6.4	103
The Programming Mode Group	G90, G91	8.4.6.5	104
The Preset Position Group	G28, G29, G92, G96, G98, G99	8.4.6.6	104
The Coordinate Systems Group	G54, G55, G56, G57, G59	8.4.6.7	105
The Polar Programming Group	G15, G16	8.4.6.8	106
The Compensation Group	G39, G40, G41, G42	8.4.6.9	108
The Scaling Group	G50, G51, P	8.4.6.10	114
The Rotation Group	G68, G69	8.4.6.11	115
The Plane Selection Group	G17, G18, G19	8.4.6.12	115

8.4.6.1. The Interpolation Group

The Interpolation Group allows you to specify the type of motion for interpolation. These G codes are retained until superseded in the NC program by another code from the Interpolation group.

The supported interpolation G codes are:

Info Table: Interpolation Group			
Code	Function	Section	Page
G00	Rapid Traverse	9.4	133
G01	Linear interpolation	9.1	129
G02	Circular interpolation (clockwise)	9.2	130

G03	Circular interpolation (counterclockwise)		
-----	---	--	--

8.4.6.2. The Units Group

By default, an NC program is interpreted using the units of measure (inch or metric) specified using the Units command on the Setup menu.

The codes in the Units Group, G70 (inch) and G71 (metric), are used to override the Units setting for the entire program.

If the code is placed at the beginning of the program before any tool motions are made, that unit of measure is assumed for the entire program. If placed later in the program, only the parts of the program following the code are affected.

These codes can be used to switch between inch and metric modes throughout the program.

The Fanuc equivalents, G20 (inch) and G21 (metric), can also be used.

Info Table: Units Group	
Code	Function
G70	Inch Units
G71	Metric Units
G20	Fanuc inch units
G21	Fanuc metric units

8.4.6.3. The Wait Group

Wait Group codes apply only to the block in which they appear. The program does not continue until the wait conditions are satisfied.

The supported Wait Group codes are:

Info Table: Wait Group	
G04	<p>Dwell (wait)</p> <p>Pause between motions on all axes for the number of seconds specified by the F code, then continue the program. This is used primarily for robot integration. Because the F code is used to specify the number of seconds, you cannot also specify a new feed rate in the same block.</p> <p>Example: G04F10; Wait for 10 seconds</p> <div style="border: 1px solid black; padding: 10px; margin-top: 10px;">  <p style="margin-left: 20px;">Do not use G04 to create a pause for a tool change during a program. Use G05 instead.</p> </div> <p style="margin-left: 20px;">Safety</p>

G05	<p>Pause</p> <p>Used for operator intervention. Stop motion on all axes until the operator manually resumes program execution using the Run/Continue command or the Run button .</p>
G25	<p>Wait until input goes high before executing the operations in this block.</p> <p>Used for robot synchronization (see 12 Automation Integration, pg. 166).</p> <p>Example: G25H13; Wait until user input 3 goes high.</p>
G26	<p>Wait until input goes low before executing the operations on this block. Used for robot synchronization (see 12 Automation Integration, pg. 166).</p> <p>Example: G26H12; Wait until user input 2 goes low.</p>
G31	<p>Move linearly to a specified coordinate but monitor the state of a specified input during motion. If the state of the input changes from High to Low or from Low to High (as specified), then stop the motion. Jump to a specified line in the NC program to continue.</p> <p>The H word specifies the input to watch (see 8.4.7 H Code: Input Selection Number, pg. 116). If a negative sign is used before the input number, the motion will stop if the input state changes from High to Low. Otherwise, the motion will stop if the input state changes from Low to High.</p> <p>The P word specifies the line number to jump to (see 8.4.15 P Code: Subprogram Reference Number, pg. 126).</p> <p>Example 1: G31 X5 Y5 Z0.5 H11 P500; Move linearly to X5Y5Z0.5. If input 1 changes from Low to High, stop the motion. Continue at line 500 in the program.</p> <p>Example 2: G31 X3 Y2 Z1 H-12 P30; Move linearly to X3Y2Z1. If input 2 changes from High to Low, stop the motion. Continue at line 30 in the program.</p>

8.4.6.4. The Canned Cycle Group

Canned Cycle codes allow you to perform a number of tool motions by specifying just one code. Canned cycle codes are typically used for repetitive operations to reduce the amount of data required in an NC program. Canned cycle codes are retained until superseded in the program by another canned cycle code.

Detailed information on many canned cycles is presented in chapter 9, as detailed below.

The supported Canned Cycle codes are listed below.

Info Table: Canned Cycle Group			
Code	Function	Section	Page
G80	Canned cycle cancel	9.6.1	136
G81	Canned cycle drilling	9.6.2	136
G83	Canned cycle peck drilling	9.6.2	136
G82	Canned cycle drilling with dwell	9.6.3	138

G84	Thread tapping	9.6.4	139
G85	Boring cycle	9.6.5	139
G86	Straight drilling with spindle stop	9.6.6	140
G89	Boring with dwell	9.6.7	141

8.4.6.5. The Programming Mode Group

Programming Mode G codes select the programming mode, absolute (G90) or incremental (G91). These codes remain in effect until superseded by each other. The default code on program start up is G90.

When using absolute programming, all X, Y, and Z coordinates are specified relative to origin of the current coordinate system. When using incremental programming, each motion to a new coordinate is specified relative to the previous coordinate.

The supported Programming Mode codes are listed in this table.

Info Table: Programming Mode Group	
Code	Function
G90	Absolute programming mode: All X, Y, and Z axes coordinates are specified relative to a (0,0,0) location on the milling center.
G91	Incremental programming mode: Each motion to a new coordinate is specified relative to the previous coordinate.

8.4.6.6. The Preset Position Group

The Preset Position G codes move the tool to a predetermined position or affect how future motions will be interpreted.

The supported Preset Position codes are listed in this table.

Info Table: Preset Position Group			
Code	Function	Section	Page
G28	Homes the machine. Can specify a point to pass through on the way to the home position.	8.4.6.6.1 G28 and G29: Homing Commands	105
G29	Return to reference point: Moves the tool to a coordinate specified by XYZ. Typically used after a G28 code.		
G92	Preset position: This code works like the Set Position command under the Setup Menu. The X, Y, and Z coordinates following a G92 code define the new current position of the tool.	8.4.6.6.2 G92: Preset Position	105
G98	Rapid move to initial tool position after canned cycle complete.	9.6 Canned Cycle Programming	135
G99	Rapid move to point R (surface of material or other reference point) after canned cycle complete.		

8.4.6.6.1. G28 and G29: Homing Commands

The Homing feature in the control software sends the machine to the predefined Home position (0,0,0). This is used as a reference for other motion.

The homing commands (G28, G29) allow you to return to and check this established position. The milling center uses this point as a reference for all machine coordinate movements. This allows you to use the Soft Limits and Coordinate Systems commands (under the Setup Menu) to move the milling center consistently to the same location.

Before you can use any homing commands, or the Soft Limits and Coordinate Systems commands, you must use the Set/Check Home command to establish an initial reference point. See 5.4 Homing, pg. 61, for information on using the Set/Check Home command.

Using G28 Code

G28 homes the machine, zeroing the machine coordinates. Optionally, the machine can be instructed to pass through specified coordinates on its way to the home position. For example, G28 X1 Y1 Z2 commands the machine to pass through X1 Y1 Z2 and then move to home position.

Using G29 Code

The G29 code moves the tool at a rapid traverse rate to a coordinate specified by XYZ. If you have set an intermediate point on one or more axes, the machine first rapids from the current position to the intermediate point then continues to the specified destination. If you command a G29 code in incremental mode, your specified XYZ point is relative to the intermediate point. If you have not specified an intermediate point, your specified XYZ point is relative to the current position. Use the G29 code after a G28 code to return the tool to a position closer to the part. The example below shows the use of a G28 code and a G29 code.

```
N1G28X2Z-1; INTERMEDIATE POINT THEN HOME N2G29X4Z1; GO TO G29 POINT
```

8.4.6.6.2. G92: Preset Position

The G92 code is used to initialize the current tool position. In other words, the G92 code can be used to redefine the X, Y and Z values of the tool's current position. The X, Y, and Z coordinates following a G92 code define the new current position of the tool.

The tool position can also be redefined through the control software, by clicking Setup | Set Position in the Main Menu.

8.4.6.7. The Coordinate System Group

Use the Coordinate System codes to establish multiple coordinate systems on one or more workpieces to create multiple parts.

For instance, you can run a part program using a typical coordinate system (with the point of origin on the left side of the workpiece next to the chuck, along the centerline of the workpiece), and then select another coordinate system which has its origin at a different point on the surface of the workpiece.

Multiple coordinate systems can be useful for different size workpieces, or for special set-up conditions.

There are seven coordinate system codes. One of these codes (G53) is used for rapid traverse motion to specified machine coordinates. The other six codes allow you to make up to six individual parts on the same workpiece by specifying different work coordinate systems for each part.

The coordinate system codes are G54 through G59, referring to coordinate systems 1 through 6 respectively. These coordinate systems may be set through the Coordinate Systems command on the Setup Menu.

Info Table: The Coordinate System Group						
G 53	For rapid traverse motion to specified machine coordinates.					
G Code	G54	G55	G56	G57	G58	G59
Coordinate System Activated	1	2	3	4	5	6

8.4.6.8. The Polar Programming Group

The Polar Programming Group codes allow you to perform programming operations based on polar coordinates (as opposed to Cartesian coordinates).

The supported Polar Programming codes are listed in this table.

Info Table: Polar Programming Group	
Code	Function
G15	Polar programming OFF
G16	Polar programming ON

Using polar coordinates allows you to specify a radius and an angle by specifying a G16 code (polar programming on), then X, Y, and Z codes. The X code specifies the radius, the Y code specifies the angle in degrees, and the Z code specifies the height at the end of the cut, as in linear interpolation.

A G15 code is used to cancel the polar programming mode.

Polar programming can be used in both absolute and incremental programming modes. The point taken to be the center of the commanded motion depends on whether using absolute or incremental mode, and on whether or not the radius (X) value is specified, as follows:

Info Table: Polar Programming in Absolute and Incremental Modes			
Mode	Activated by	Center Point Location if Specifying Radius (X) and Angle (Z) Codes	Center Point Location if Specifying on Angle (Y) Code
Absolute	G90	The defined workpiece origin	The current location
Incremental	G91	The current location	

Polar programming is especially useful when writing programs for machining bolt holes. An L code (see 8.4.11 L Code: Angle of Arc Resolution, Loop Counter, pg. 118) can be used as a multiplier for the angle value. See the following example.

NC Code Example:
G0 X0 Y0 Z0.07

M03 G91 X1.5 Y1 G16 X.75Y0 M98 P1 L12 M02 O1 Y30 G81 Z-.1 R0 G80 M99													
Code	Explanation												
G0X0Z0.07M03	Rapid motion to X0Z0.07. Spindle ON.												
G16 G91X2Z0 M98P1L12 M2	<table border="1"> <tr> <td>G16</td> <td>Turn Polar programming ON.</td> </tr> <tr> <td>G91</td> <td>Incremental programming mode ON.</td> </tr> <tr> <td>X2Z0</td> <td>Move to a point 2 inches from the current position, at an angle of 0 degrees.</td> </tr> <tr> <td>M98 P1</td> <td>Call subprogram 1.</td> </tr> <tr> <td>L12</td> <td>Sets the number of repeats to 12.</td> </tr> <tr> <td>M2</td> <td>End program</td> </tr> </table>	G16	Turn Polar programming ON.	G91	Incremental programming mode ON.	X2Z0	Move to a point 2 inches from the current position, at an angle of 0 degrees.	M98 P1	Call subprogram 1.	L12	Sets the number of repeats to 12.	M2	End program
G16	Turn Polar programming ON.												
G91	Incremental programming mode ON.												
X2Z0	Move to a point 2 inches from the current position, at an angle of 0 degrees.												
M98 P1	Call subprogram 1.												
L12	Sets the number of repeats to 12.												
M2	End program												
O1Z30 G81Z-.1R0 G80	<table border="1"> <tr> <td>O1</td> <td>Subprogram label 1.</td> </tr> <tr> <td>Z30</td> <td>Move to position 30 degrees from current position.</td> </tr> <tr> <td>G81</td> <td>Start canned drilling cycle.</td> </tr> <tr> <td>Z-.1</td> <td>Drill to Z – 0.1</td> </tr> <tr> <td>R0</td> <td>Retract to Z0 after cycle complete.</td> </tr> <tr> <td>G80</td> <td>End canned drilling cycle.</td> </tr> </table>	O1	Subprogram label 1.	Z30	Move to position 30 degrees from current position.	G81	Start canned drilling cycle.	Z-.1	Drill to Z – 0.1	R0	Retract to Z0 after cycle complete.	G80	End canned drilling cycle.
O1	Subprogram label 1.												
Z30	Move to position 30 degrees from current position.												
G81	Start canned drilling cycle.												
Z-.1	Drill to Z – 0.1												
R0	Retract to Z0 after cycle complete.												
G80	End canned drilling cycle.												
M99	End of subprogram, return to main program.												
Summary	The example combines the use of polar programming with a canned cycle and a subprogram to drill a hole at 30 degree increments. The L value was determined by dividing 360 degrees by 30 degrees.												

A second example is shown below.

NC Code Example:	
G0 X0Y0Z0	
G16	
G91X2Z0	
Z-.1	
M98P1L90	
G15	
M2	
O1Y1	
M99	
Code	Explanation
G16	G16 Turn Polar programming ON.
G91X2Z0	G91 Incremental programming mode ON.
Z-.1	X2Z0 Move to a point 2 inches from the current position, at an angle of 0 degrees.
M98P1L90	Z-.1 Move 0.1 inches in the negative Z direction.
G15	M98 P1 Call subprogram 1.
	L90 Sets the angle of the arc to 90 degrees.
	G15 Turn Polar programming OFF.
M2 O1Y1 M99	M2 End program.
	O1 Subprogram label 1.
	Y1 Move to Y1.
	M99 End of subprogram, return to main program.

8.4.6.9. Compensation Functions Group

Cutter compensation automatically adjusts to compensate for variations in a cutting tool's radius. It uses tool radius values from the Setup Offsets table to determine the compensation offset value.

The supported compensation codes are listed in this table.

Info Table: Compensation Functions Group			
Code	Function	Section	Page
G39	Corner offset circular interpolation	8.4.6.9.1	109
G40	Cancel cutter compensation	8.4.6.9.2	110
G41	Left cutter compensation	8.4.6.9.3	112
G42	Right cutter compensation		
D	Specifies offset number from offset table.	8.4.6.9.4	113

8.4.6.9.1. G39: Corner Offset Circular Interpolation

The G39 code inserts an arc at the corner of a cutter compensated tool path. The G39 instructs the cutter compensation function to complete the current segment by moving to its default endpoint (the endpoint of the Offset Vector). It then creates an arc (with a radius equal to the offset value), starting at the buffered segment's default endpoint, and ending at the endpoint of the offset vector (IJ). Here is an example of an NC program using G39:

NC Code Example:	
G91	
G41D1...	
...	
Y.25	
X.25	
G39I0J-1; CORNER OFFSET	
Code	Explanation
G91	Incremental mode
G41D1...	Start left cutter compensation, using entry #1 from the offset table.
...	Specifies the cutting path.
Y.25	
X.25	
G39I0J-1; CORNER OFFSET	Complete the current segment and move to the default endpoint (I10J-1), creating an arc with a radius of the offset distance.

8.4.6.9.2. G40: Cancel Cutter Compensation

Use the G40 Cancel cutter compensation code to cancel cutter compensation. G40 is effective for only one move.

There are six methods for cancelling cutter compensation, described in the table below.

Info Table: Cancelling Cutter Compensation			
No.	Method	Explanation	Example
1	G40	The G40 code cancels cutter compensation. The cutter moves from the offset path to the programmed end point.	G91G41D1 ... X.25 Y-.25 Z.2; RETRACT G40 X-.5Y-.25 M2
2	G40XYZ	The G40 cancels the cutter compensation, but a subsequent motion (X-.5Y-.25) is included in the program. The tool moves towards the programmed path in the direction of X-.5Y-.25.	G91G41D1 ... X.25 Y-.25 Z.2;RETRACT G40X-.5Y-.25 M2
3	G40XYZIJK	An IJK vector specifies the direction of movement after cutter compensation is cancelled.	G91G41D1 ... X.25 Y-.25 Z.2; RETRACT G40X-.5Y-.25I-.5J-.25 M2

4	D0	<p>Setting the offset number to zero cancels cutter compensation. The cutter moves from the offset path to the programmed end point.</p> <p>Setting the offset number to zero has the same effect as cancelling cutter compensation (see 1). However, cutter compensation is still active.</p>	<p>G91G41D1 ... X.25 Y-.25 Z.2; RETRACT D0 X-.5Y-.25 M2</p>
5	D0XYZ	<p>The D0 cancels the cutter compensation, but a subsequent motion (X-.5Y-.25) is included in the program. The tool moves towards the programmed path in the direction of X-.5Y-.25.</p> <p>Setting the offset number to zero has the same effect as cancelling cutter compensation. However, cutter compensation is still active.</p>	<p>G91G41D1 ... X.25 Y-.25 Z.2;RETRACT D0 X-.5Y-.25 M2</p>
6	G41/42D0XYZIJK	<p>An IJK vector specifies the direction of movement after cutter compensation is cancelled.</p> <p>Setting the offset number to zero has the same effect as cancelling cutter compensation. However, cutter compensation is still active.</p>	<p>G91G41D1 ... X.25 Y-.25 Z.2; RETRACT D0 X-.5Y-.25I-.5J-.25 M2</p>

8.4.6.9.3. G41 and G42: Left and Right Cutter Compensation

The G41 and G42 codes command left and right cutter compensation as illustrated below.

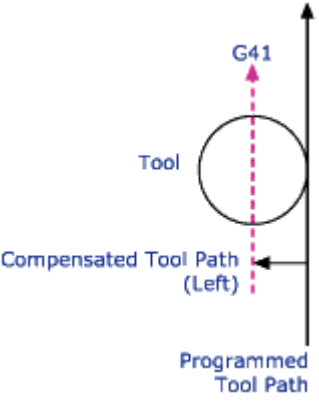
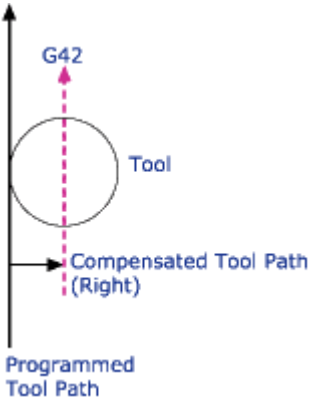
Info Table: Left and Right Cutter Compensation		
Code	Explanation	Explanation
G41	Left compensation when you need to move the tool to the left of the programmed tool path.	 <p>The diagram shows a vertical line representing the 'Programmed Tool Path' with an upward-pointing arrow. A circle representing the 'Tool' is positioned to the right of this line. A vertical dashed pink line, labeled 'G41' at the top, passes through the center of the tool. A horizontal arrow points from the programmed path to the left, towards the dashed line, which is labeled 'Compensated Tool Path (Left)'.</p>
G42	Right compensation when you need to move the tool to the right of the programmed tool path.	 <p>The diagram shows a vertical line representing the 'Programmed Tool Path' with an upward-pointing arrow. A circle representing the 'Tool' is positioned to the left of this line. A vertical dashed pink line, labeled 'G42' at the top, passes through the center of the tool. A horizontal arrow points from the programmed path to the right, towards the dashed line, which is labeled 'Compensated Tool Path (Right)'.</p>

In the example below, left cutter compensation is enabled and the compensation value is equal to offset value 1 from the Offset Table.

NC Code Example:

```
G0X0Y0
G91; INCREMENTAL
G41D1; CUTTER COMP ON
G1X.25Y.25; MOVE TO P1
G1X0Y1; MOVE TO P2
G1X.75Y0; MOVE TO P3
G1X.25Y-.25; MOVE TO P4
G1X0Y-.75; MOVE TO P5
```

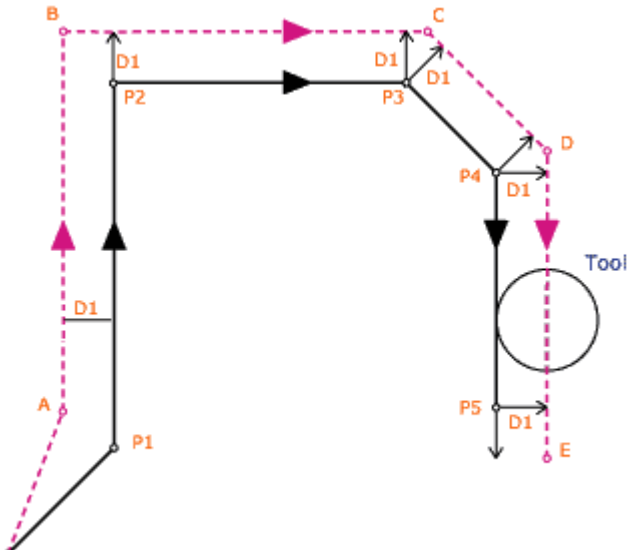
Explanation	Motion
<p>The black lines show the specified tool path.</p> <p>The purple dashed lines show the compensated tool path that the tool will follow.</p> <p>Note that the distance between the two paths is always as specified by D1.</p>	

8.4.6.9.4. D: Specify Cutter Compensation Value

The D code selects a value for cutter compensation or tool offset adjustments by referencing values in the control program offset table.

For example, D1 selects entry #1 from the offset table.

D0 cancels compensation.

The offsets specified by D1 to D199 are set in the Setup Offsets table, accessed by clicking **Setup | Offsets** in the Main Menu.

Note that an NC program will use the offset values as listed in this window, without converting for metric or imperial systems. The Units selection area in the window converts the values in this window.

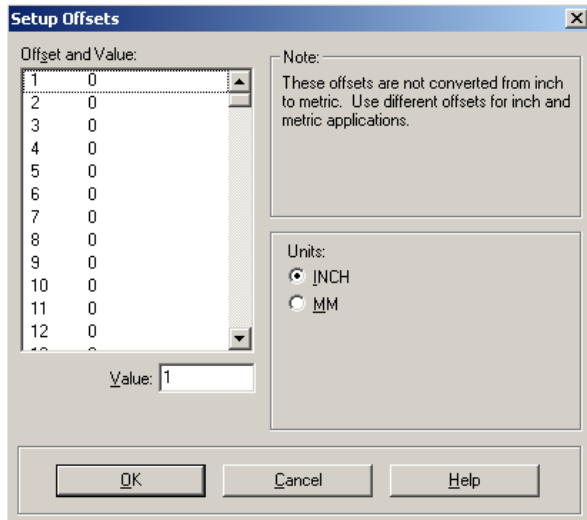

8.4.6.10. Scaling Group

Use the Scaling codes to scale one or more axes of a part from a fixed scaling origin. You can scale the entire piece uniformly, or set different scaling factors for each axis.

Use a P Code to scale an entire piece uniformly along each axis. When you specify a value for P, subsequent motions are scaled by that value, starting from the scaling center. The control software measures the distance from the scaling center to the start and end points of the shape, then multiplies those values by the P value.

The code I is used to specify the X axis center of scaling, see 8.4.8. I Code: X Axis Coordinate of Center Point, pg. 116. The J code is used to specify the Y axis center of scaling, see 8.4.9 J Code: Y Axis Coordinate of Center Point, pg. 117. The code K is used to specify the Z axis center of scaling, see 8.4.10 K Code: Z Axis Coordinate of Center Point, pg. 117.

If you do not specify any of the coordinates for the scaling center, the current position for unspecified axes becomes the scaling center coordinate



Using a P Code to scale an entire piece will affect the Z axis, which will affect your programmed depths of cuts. Use caution when performing scaling operations.

Product Care

Use the following codes for scaling:

Info Table: Scaling Group	
Code	Function
G50	Cancels scaling
G51	Invokes scaling
P	Uniform scale multiplier

The example below demonstrates the use of scaling:

Example Code: Scaling		
Code	Explanation	
G51X0Y0Z0I2J2K1	G51	Initiates scaling.
	X0Y0Z0	Sets the origin of scaling to X0Y0Z0.
	I2J2K1	Scales X and Y axes by 2, and the Z axis by 1.

8.4.6.11. Rotation Group

Rotation codes allow you to rotate a programmed shape around a rotation origin. You can rotate a shape on any plane, one plane at a time. Use the Rotation code to modify an NC program when a work piece has been rotated from the programmed position on the machine.

The supported Rotation codes are listed below.

Info Table: Rotation Group	
Code	Function
G68	Invokes rotation.
G69	Cancels rotation.
R	When used with G68, specifies the angle of rotation, in degrees.

This example demonstrates the use of rotation:

Example Code: Rotation		
Code	Explanation	
G68X0Y0R90	G68	Initiates rotation.
	X0Z0	Sets the origin of rotation to X0Y0.
	R90	Sets rotation to 90 degrees.

8.4.6.12. Plane Selection Group

This group of codes allows you to select different planes for circular interpolation.

For more information on circular interpolation in planes other than XY, see 9.3 Circular Interpolation Programming in Other Planes, pg. 132.

The supported Plane Selection Group codes are listed in this table.

Info Table: Selecting a Plane for Circular Interpolation		
Code	Selects Plane	Arc Center Coordinates Specification
G17	XY	I for the X axis, J for the Y axis
G18	XZ	I for the X axis, K for the Z axis
G19	YZ	J for the Y axis, K for the Z axis

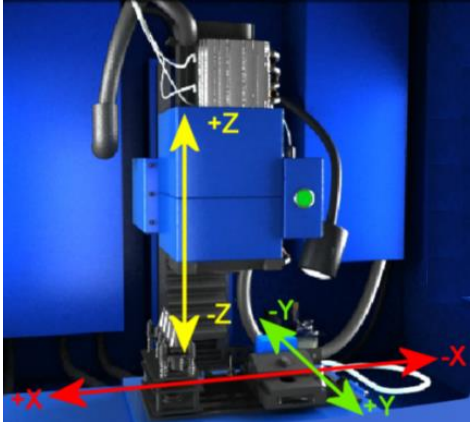

8.4.7. H Code: Input Selection Number

The H code is used to specify inputs and outputs in robot integration (see 12 Automation Integration, pg. 166).

Use the H code in conjunction with:

- The wait codes G25 and G26 to specify the input number.
The H code and input must be specified.
- The transmit codes M25 and M26 for interfacing with robots or other external devices to specify the output number.
The H code and input must be specified.

H codes specify inputs and outputs as defined in the table below.

Info Table: H Code				
H Code	H11	H12	H13	H14
Input specified for Wait Codes G25 and G26	1	2	3	4
Output specified for Transmit codes M25 and M26	1	2	3	4

8.4.8. I Code: X Axis Coordinate of Center Point

The I code specifies the X coordinate of the center of an arc or circle. If no I code is specified when specifying an arc or circle, the system uses the current X axis location as the X axis center of the arc.

The I code is used in both absolute and incremental programming modes. In Fanuc mode, all arc centers are specified in incremental mode.

The value following the I code is interpreted differently in absolute and incremental programming modes, as follows:

Info Table: I Code in Absolute and Incremental Modes		
Mode	Activated by	I value specifies:

Absolute	G90	The X coordinate of the arc/circle center, measured from the origin. Note: In Fanuc mode, all arc centers are specified in incremental mode.
Incremental	G91	The distance along the X direction from the starting point of motion to the arc/circle center.

The I code is also used with the G51 code to specify the scale factor for the X axis when performing scaling functions, including scaling each axis and mirror scaling. See 8.4.6.10 Scaling Group, pg. 114.

8.4.9. J Code: Y Axis Coordinate of Center Point

The J code specifies the Y coordinate of the center of an arc or circle. If no J code is specified when specifying an arc or circle, the system uses the current Y axis location as the Y axis center of the arc.

The J code is used in both absolute and incremental programming modes. In Fanuc mode, all arc centers are specified in incremental mode.

The value following the J code is interpreted differently in absolute and incremental programming modes, as follows:

Info Table: J Code in Absolute and Incremental Modes		
Mode	Activated by	J value specifies:
Absolute	G90	The Y coordinate of the arc/circle center, measured from the origin. Note: In Fanuc mode, all arc centers are specified in incremental mode.
Incremental	G91	The distance along the Y direction from the starting point of motion to the arc/circle center.

The J code is also used with the G51 code to specify the scale factor for the Y axis when performing scaling functions, including scaling each axis and mirror scaling. See 8.4.6.10 Scaling Group, pg. 114.

8.4.10. K Code: Z Axis Coordinate of Center Point

The K code specifies the Z coordinate of the center of an arc or circle. If no K code is specified when specifying an arc or circle, the system uses the current Z axis location as the Z axis center of the arc.

The K code is used in both absolute and incremental programming modes. In Fanuc mode, all arc centers are specified in incremental mode.

The value following the K code is interpreted differently in absolute and incremental programming modes, as follows:

Info Table: K Code in Absolute and Incremental Modes		
Mode	Activated by	K value specifies:
Absolute	G90	The Z coordinate of the arc/circle center, measured from the origin. Note: In Fanuc mode, all arc centers are specified in incremental mode.
Incremental	G91	The distance along the Z direction from the starting point of motion to the arc/circle center.

The K code is also used with the G51 code to specify the scale factor for the Z axis when performing scaling functions, including scaling each axis and mirror scaling. See 8.4.6.10 Scaling Group, pg. 114.

8.4.11. L Code: Angle of Arc Resolution, Loop Counter

The L code is used in three unrelated ways, as listed below.

Section Contents: Angle of Arc Resolution, Loop Counter		
Description	Section	Page
To specify the resolution of an arc or circle	8.4.11.1 L Code: Angle of Arc Resolution	118
As a loop or program counter	8.4.11.2 L Code: Loop and Program Counter	120

By default, an L code that is not specifically used as a counter is treated as specifying the arc/circle resolution factor.

8.4.11.1. L Code: Angle of Arc Resolution

When specifying an arc or circle, the L code specifies the angle of arc resolution in circular interpolation programming. When the system executes a circular motion, it splits the arc into a series of line segments to approximate the circle. The L code specifies the resolution in terms of the angle in degrees across which a line segment approximates a portion of the arc. Setting a low value of L increases the resolution of the arc or circle, and thus creates a smoother cut. However, very fine resolutions may cause the milling center to hesitate while cutting.

The table below illustrates the effect of the L value.

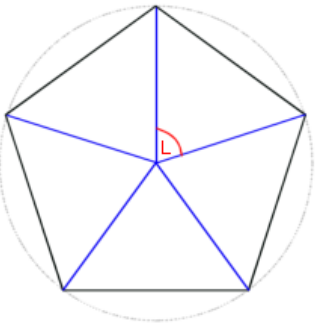
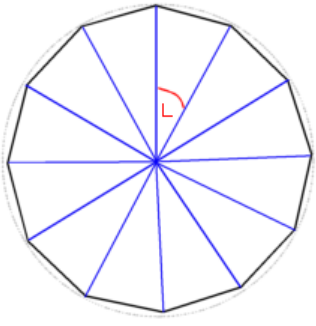
Info Table: L Code Specifying Angle of Arc Resolution		
	High Value of L	Low Value of L
Example		
Resolution	Resolution is low; the approximated circle is made up of few lines.	Resolution is higher; the approximated circle is made up many lines.

Default Settings

The default setting for the milling center is 2 degrees, and typically this will work quite well. The L code can be a fraction of a degree (such as L0.5), but it must be large enough so that the milling center will move at least the minimum motion distance (0.0005") on each of the straight line motions.

Calculating L

If you know the chord length you would like used when approximating an arc or circle, calculate the angle L as follows:

Calculation: Calculating the Value of L	
Calculation	Where:
$L = \frac{360 \cdot c}{2\pi \cdot R}$	c is the desired chord length.
	R is the arc or circle radius.
Example	To calculate the L value for a chord length of 0.001" and a radius of 0.5", you would write the equation as: $L = \frac{360 \cdot c}{2\pi \cdot R} = \frac{360 \cdot (.001)}{2\pi \cdot .5} = 0.1146^\circ$

Negative L Values

A negative value for L will generate a normalized L factor, calculated as:

$$\text{Angle } \{degrees\} = L / \text{Radius } \{inches\}$$

For example, with the default L factor of -1:

Calculation: Calculating the Angle of Arc when Using Normalized L of -1			
Radius	L Value	Calculation	Result
0.5 inch	-1	Angle = L/0.5 = 1/1	The arc will have line segments approximating every 2 degree of the arc.
1 inch	-1	Angle = L/R = 1/1	The arc will have line segments approximating every 1 degree of the arc.
2 inches	-1	Angle = L/2 = 1/2	The arc will have line segments approximating every 0.5 degrees of the arc.

8.4.11.2. L Code: Loop and Program Counter

The L code functions as a counter when used with codes M98 and M47:

Info Table: L Code Used as a Counter			
When Used With	L Specifies	Section	Page
M47	The number of times a program must be repeated.	8.4.12 M Codes: Miscellaneous Codes	120
M98	The number of times a subprogram must be repeated.	9.7 Subprogram Programming	143

8.4.12. M Codes: Miscellaneous Codes

M codes control a variety of milling center functions while a part program is running.

The following general rules must be followed when using M codes:

- Only one M code may be used in a program block.
- M codes should be specified in their own blocks. Using M codes together with other codes in a block can cause confusion about which code is executed first, however:
 - All M codes used to turn on a device, such as the spindle, execute at the beginning of the tool motion for that block of NC code.
 - All M codes used to turn off a device execute after the tool motion for that block is completed.

The supported M codes are listed in this table.

Info Table: Miscellaneous Mode Group		
Subgroup	Code	Function
Program Stop/End Group	M00	Pause Allows you to place a pause in your code. Acts like a G05 pause.
	M01	Optional Stop Allows you to place an optional pause in your code. Place an M01 in the block of code where you would like to pause. There are switches to activate or deactivate the Optional Stop code in the Run Settings window (see 5.6.2 Modifying Run Settings, pg. 67) and on the Operator Panel (see 5.3.4.2 The Operator Panel, pg. 60). With Optional Stop on, the M01 works like a G05 pause. With Optional Stop off, the M01 code is ignored, and the other codes on the block are executed as usual.
	M02	End of Program Takes effect after all motion has stopped; turns off drive motors, and all outputs, including the spindle and the accessory outlets.
	M30	End of program: Same as M02.

Spindle and Axis Motor Group	M03	Spindle Motor On Activated concurrently with motion specified in the program block; remains in effect until superseded by M05.
	M05	Spindle Motor Off Activated after the motion specified in the program block; remains in effect until superseded by M03.
	M38	Drive Motors Standby Typically used to turn the drive motors to standby (low power) before a pause (G05); activated after the motion specified in the program block. M38 is useful when the machine is left unattended for a long time, such as the interval before reloading a part.
Tool Change Group	M06	Tool Change (see 10.3 Writing an NC Program for Multiple Tools, pg. 147)
I/O Group	M25	Sets the output specified by the H command to On. Used for robot synchronization. Use the H code to specify an output (see 8.4.7 H Code: Input Selection Number, pg. 116). See 12 Automation Integration, pg. 166
	M26	Sets the output specified by the H command to Off. Used for robot synchronization. Use the H code to specify an output (see 8.4.7 H Code: Input Selection Number, pg. 116). See 12 Automation Integration, pg. 166
Program Management Group	M20	Chain to Next Program This code is used to chain several NC files together. It is placed at the end of a part program and is followed on the next line by the file name of another program to be executed when all motion stops. Below is an example of a part program chain to another program: N37 Z.2 N38 M20 PROGRAM2.NC; Chain to PROGRAM TWO If the two programs you are chaining are not in the same directory on your computer, you must specify the full path name for the next program file. If the software cannot locate the specified file, you will be prompted to find it.
	M22	Output current position or other information to file. See 8.4.12.1 M22 Code: Output Current Position to File, pg. 122.
	M47	Rewind Restarts the currently running program; takes effect after all motion comes to a stop. Typically used with an L code to repeat a program a set number of times.

	M98	<p>Call to subprogram</p> <p>Use the P code to specify the subprogram starting block number. Use the L code to specify the number of times the subroutine is executed. You can nest subprogram calls to a depth of 20.</p> <p>See 9.7 Subprogram Programming, pg. 143.</p>
	M99	<p>Return from Subprogram</p> <p>Goto</p> <p>See 8.4.12.2 M99 Code: Return from SubProgram, Goto, pg. 124, and 9.7 Subprogram Programming, pg. 143.</p>
	M105	<p>Operator Message</p> <p>A nonstandard Intelitek code used to display messages.</p> <p>See 8.4.12.3 M105 Code: Operator Message, pg. 124.</p>
Homing Group	M111	Home the X axis.
	M112	Home the Z axis.

8.4.12.1. M22 Code: Output Current Position to File

The M22 code is used to write information to a file while a program is running. Typically, this code is used when digitizing to write the current X and Z machine coordinates to a file. The proper format for using this code is:

M22([filename.ext [,A]]) [text and macros]

Items in brackets [] are optional, except that a filename is required for the first M22 code used.

Info Table: Using the M22 Code	
<i>M22([filename.ext [,A]]) [text and special codes]</i>	
Parameter	Notes
Filename	<ul style="list-style-type: none"> • Must be enclosed in parentheses. • Must be specified the first time the M22 code is used in the program. • If not specified with subsequent M22 codes, the first specified file name will be used. However, empty parentheses must still be used. • If the file does not exist, it will be created
A	<ul style="list-style-type: none"> • If the file name is followed by ,A: <ul style="list-style-type: none"> ▪ The new data is added to the end of the existing file; the existing data in the file is not deleted. ▪ The new data is automatically added on a new line in the file. • If the file name is not followed by ,A, existing data in the file is deleted, and the new data is added.

text	<ul style="list-style-type: none"> • Enter standard text to be written in each line. Text can be written in front of, between, or after macros. • If no text or macros are specified, the actual machine position data will be written.
special codes	<ul style="list-style-type: none"> • Codes such as @TD (time of day) and @ (cycle number) can be specified to include a range of data. See below in this section for a table of all available special codes.

The following pseudo-code illustrates the use of the M22 code

Example Code: Use of M22
<pre> ... ; code to move to position ; Open my1.xz, discard contents, write coordinates M22(my1.xz) ... ; code to move to next position ; Append to currently open data file M22() ... ; code to move to next position ;Open my2.xz and append coordinates M22(my2.xz,A) </pre>

The following special codes can be used with M22 to generate run-time reports.

Info Table: Special Codes for Use With M22	
Code	Description
@X	Current X position (in current coordinate system)
@Z	Current Z position (in current coordinate system)
~ (tilde)	New line (starts a new line in the file)
@TD	Time of day (12hour): "11:59:59AM"
@TC	Time (elapsed) for cycle: "99:11:59" (0's trimmed from left)
@TT	Time total (of program run): "99:11:59"
@TA	Time Average (per cycle): "99:11:59" ("?:?:??" if first part)
@TL	Current Tool number: "5"
@C	Cycle number (current pass): "3"
@D	Date: "12/31/97"
@FN	Current file (without path): "PART.NC" ("UNTITLED.NC" if untitled)
\t	Tab
\\	Outputs a single backslash ('\') character to the file

Below is another annotated example of the use of M22 in an NC program. All text on the same block, after the closing parenthesis, is output to the file, with all valid special codes being replaced as it is written.

Example Code: Use of M22 with Special Codes
<pre> ; Start of file ... ; Process a single part </pre>

```
; Output part time statistics to file c:\Reports\Stats.txt (c:\Reports directory must exist)
M22 (c:\Reports\Stats.txt,A) Part #@C processed in @TC.
M47 L50 ; We want to process 50 parts.
```

8.4.12.2. M99 Code: Return from SubProgram, Goto

The M99 code has two specific uses; it can be used as a command to return from a subprogram or it can be used as a Goto command.

8.4.12.2.1. Using M99 with Subprograms

When used in a subprogram, this code returns the program flow to the block following the last M98 (Call to Subprogram) command.

If the M98 code is used together with an L code to specify multiple calls to the subprogram, the M99 code will return to the block containing the M98 code until all the specified number of subprogram calls have been made; then it will proceed to the block following the M98.

You can use the P code with a block number to specify a different block to jump to; however, if this feature is used from a nested subprogram call, all return targets are discarded. The rules for a Goto target block apply to this use as well.

8.4.12.2.2. Using M99 as a Goto Command

The M99 code can be used in the main NC program as a Goto command to jump to any line before the first subprogram (as denoted by an O code).

Use the P code to identify the block number being jumped to. Control is transferred to the first occurrence of this N code; it cannot be used to transfer control between chained programs.

This command can be used anywhere in the program to change the flow of program execution. It is good programming practice to place this command on a line by itself to improve the program's readability, for example:

```
M99P50; Jump to line 50 in the current program.
```

8.4.12.3. M105 Code: Operator Message

This command is used to display messages in the control software. It provides a way to display messages to the operator on the message bar while an NC program is running. To pause the program with a custom message, place a ! character at the start of the message.

By default, the message is centered, displayed as a Normal Message, and is persistent, meaning that it is not cleared until the program clears it or until the next message is displayed.

The M105 code is used in the format: *M105 (the message); comment*

This is illustrated in the example below.

Example Code: Use of M105

```
M105 (End of Roughing Segment); Normal Message, doesn't pause
```

Message functionality can be altered using the special codes listed below.

Info Table: Special Codes for Use With M105	
Code	Function
!	Displays the message and performs a pause requiring operator intervention to continue.
~	Displays the message as a Warning Message.
\b	Beeps when the message is shown.

The M105 code is used with special codes as in the format below:

M105 (alternate character plus the message) ;comment

For example:

Example Code: Use of M105 with Special Codes
M105 (~WARNING); Warning Message, doesn't pause
M105 () ; Clears current message
M105 (!Please stop and read this!); Normal Message, pauses
M105(~!! Proceed with Caution!); Warning Message, pauses
M105 (\b\b\b); Clears current message, beeps 3 times, and doesn't pause

8.4.13. N Code: Block Number

N codes have two uses:

- To provide destination references for Goto codes (M99) elsewhere in the program.
- To clearly show the organization of the code and improve readability.

Using the N code is optional; however, when you do use the N code, it must be the first character in the block.

Apart from the uses listed above, N codes are ignored by the control software. Their presence, absence, or sequential value does not affect the execution of the NC program in any way, unless the target of a Goto is missing.

You may have N codes on some blocks and not on others. N code sequence numbers do not have to be in order, but regular sequential order does make it easier to follow and reference sections of the program.

You can automatically number, renumber, or remove numbering from the program using the control software. Click **Edit | Renumber** in the Main Menu.

8.4.14. O Code: Subprogram Block Number

The O code is used to indicate the start of a subprogram, and must be followed by a number which identifies the subprogram. The O code replaces the N code in the first block of the subprogram.

To call a subprogram, use the M98 code using the P code to specify which subprogram to execute. To return from the subprogram, use the M99 code. See 9.7 Subprogram Programming, pg. 143.

Only the first block in the subprogram contains the O code. The remaining blocks may contain N codes. The O and N code numbers may be used to help identify and set apart the subprogram to improve readability, for example:

Example Code: Use of O Code
M98 P50000 ;call to first subprogram ...;after first subprogram is finished, M99 code returns to this point ...
M98 P60000 ;call to second subprogram ...;after second subprogram is finished, M99 code returns to this point ...
O50000 ;start of subprogram N50010 ;first line of subprogram N50020 ;second line of subprogram N50030 M99 ; last line of subprogram ...
O60000 ;second subprogram N60010 ;first line of second subprogram N60020 ;second line of second subprogram N60030 M99 ; last line of second subprogram

8.4.15. P Code: Subprogram Reference Number

P codes are used with the following codes:

Info Table: Use of P Code			
Used with Code	To	Section	Page
G31	Reference a GOTO target block.	8.4.6.3	102
M98	Reference a subprogram using the subprogram block number.	9.7	143
M99	Specify a return block number as a GOTO target.	8.4.12.2.2	124

8.4.16. Q Code: Depth of Cut and Peck Depth

The Q code is used in canned cycles to define the depth of cut. In drilling cycles Q specifies the incremental depth of each peck.

See 9.6 Canned Cycle Programming, pg. 135.

8.4.17. R Code: Drilling Start Location

Use the R code in canned cycles to specify a Z axis reference point for peck drilling. The point can be at the material surface or at another reference point. See 9.6.2 G81 & G83: Straight and Peck Drilling, pg. 136.

The R code is also used to specify the rotation angle, in degrees, with the G68 code. See 8.4.6.11 Rotation Group, pg. 115.

8.4.18. S Code: Spindle Speed

Use the S code to set the spindle speed from within the NC program. Spindle speed is specified by the address character “S” followed by a parameter that represents the speed in RPM. For example, S750 is the designation for a spindle speed of 750 RPM.

If the spindle is off when the S code is used, the spindle speed is stored and used when the spindle is turned on again within the program by the M03 command.

8.4.19. T Code: Tool Selection

A T code is used to specify the tool (by number) from the tool ATC to be used for an operation. Tools are specified by the address character “T” followed by a parameter that represents the number of the tool. For example, T3 is the designation for tool number three.



Safety

Using multiple tools is an advanced operation and should not be attempted by persons unfamiliar with using the ProMill 8000 milling center.

See 10 Multiple Tool Programming, pg. 145.

8.4.20. X and U Codes: X Axis Coordinate

An X code specifies the coordinate of the destination along the X axis. A U code is used in absolute programming mode (G90) to specify an incremental X motion. You cannot use the U code to mix incremental and absolute programming in the same block.

8.4.21. Y and V Codes: Y Axis Coordinate

A Y code specifies the coordinate of the destination along the Y axis. A V code is used in absolute programming mode (G90) to specify an incremental Y motion. You cannot use the V code to mix incremental and absolute programming in the same block.

8.4.22. Z and W Codes: Z Axis Coordinate

The Z code specifies the coordinate of the destination along the Z axis (spindle axis). A W code is used in absolute programming mode (G90) to specify an incremental Z motion. You cannot use the W code to mix incremental and absolute programming in the same block.

8.4.23. Comment Codes

The control software allows you to add comments (notes) to your NC code lines. The control software recognizes two comment codes, a semicolon ; and an open parenthesis (. These two comment codes are equivalent. The use of either of these codes within an NC block indicates that a comment follows.

Comments must follow all other NC codes in the block. Comments are ignored when the part program is executed. Comments can be placed on a block without any NC codes.

Below is an example of an NC block with a comment:

Example Code: Comment	
Code	Explanation
X0Z0; MOVE TO ZERO POINT	The comment in the example tells us that the X and Z codes in this block command the cutting tool to move to the zero point (coordinate 0,0).

Comments can be combined with the G05 pause and the M06 tool change codes to display messages to the operator during program execution. The M105 code, however, provides a more versatile and powerful message facility (see 8.4.12.3 M105 Code: Operator Message, pg. 124).

Here is an example of an NC block with a pause coded comment:

Example Code: Comment	
Code	Explanation
G105(!ROUGH DIAMETER SHOULD BE 0.5 in.!)	When the program pauses, the comment is displayed on the message bar telling the operator to verify the diameter of the workpiece before continuing.



Take Note

The control software can strip comments from a program with a single command. To do so, right-click in the Program Editing window and select **Renumber**. Check the **Remove Comments** checkbox and click **Do it**.

The comments cannot be subsequently replaced.

9. NC Programming Routines

This chapter describes the use of the following NC programming routines:

Section Contents: NC Programming Routines		
Section	Name	Page
9.1	Linear Interpolation Programming	129
9.2	Circular Interpolation Programming	130
9.3	Circular Interpolation Programming in Other Planes	132
9.4	Rapid Traverse Programming	133
9.5	Helical Interpolation Programming	134
9.6	Canned Cycle Programming	135
9.7	Subprogram Programming	143

9.1. LINEAR INTERPOLATION PROGRAMMING

Linear interpolation is the movement of the tool in a straight line from its current position to a coordinate location specified by an NC code.

Consider the following example code: N5G90G01X1Y2Z.5F2

NC Code Example:	
N5G90G01X1Y2Z.5F2	
Code	Explanation
N5	The line sequence number is 5.
G90	Coordinates are given using absolute dimensioning.
G01	Linear interpolation is specified. The G01 code is required when switching from circular interpolation or rapid traverse positioning back to linear interpolation.
X1	X axis coordinate of end point = 1
Y2	Y axis coordinate of end point = 2
Z.5	Z axis coordinate of end point = .5

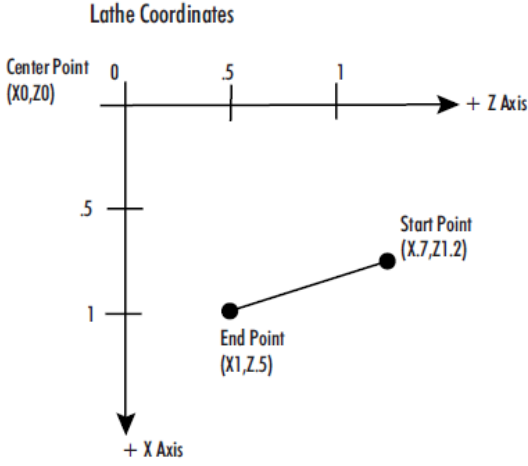
<p>Example Motion</p>	<p>If we assume that the current position of the tool is X.7, Y2, Z1.2, the tool movement generated by the example code will be as follows. (Only X and Z axes are shown.)</p>  <p style="text-align: center;">Lathe Coordinates</p> <p>Center Point (X0,Z0) 0 5 1 → + Z Axis</p> <p>5</p> <p>1</p> <p>Start Point (X.7,Z1.2)</p> <p>End Point (X1,Z.5)</p> <p>↓ + X Axis</p>
<p>Equivalent Code</p>	<p>An equivalent movement is achieved with incremental dimensioning (G91): N5G91G01X.3Y0Z-.7F2</p>

9.2. CIRCULAR INTERPOLATION PROGRAMMING IN THE XY PLANE

Note: This section presents circular interpolation in the XY plane. See also 9.3 Circular Interpolation Programming in Other Planes, pg. 132.

Circular interpolation moves the cutting tool along an arc from the starting point specified in one line to an end point specified in the next line.

The curvature of motion is determined by the location of the center point (I and J), which must also be specified in the second NC line. Whether I and J are interpreted in incremental or absolute form is specified in the Run Settings window, using the Arc Centers Incremental setting (see 5.6.2 Modifying Run Settings, pg. 67).

The direction of rotation from the starting point determines the actual shape of the arc relative to the spindle axis. A G02 code moves the tool in a clockwise (CW) motion from the starting point. A G03 code moves the tool in a counterclockwise (CCW) motion from the starting point.

The codes used in circular interpolation are listed below.

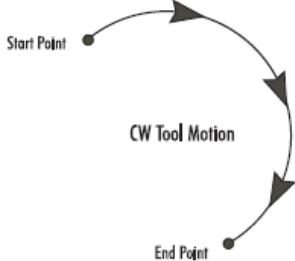
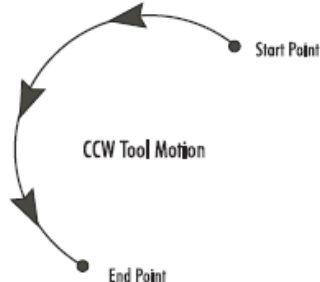
Info Table: Circular Interpolation Codes	
Code	Explanation
G02	Moves tool along circular path in clockwise direction.  A circular path with arrows indicating clockwise movement. The path starts at a point labeled 'Start Point' and ends at a point labeled 'End Point'. The text 'CW Tool Motion' is centered within the circle.
G03	Moves tool along circular path in counterclockwise direction.  A circular path with arrows indicating counterclockwise movement. The path starts at a point labeled 'Start Point' and ends at a point labeled 'End Point'. The text 'CCW Tool Motion' is centered within the circle.
I	Specifies X-axis coordinate of center point
J	Specifies Y-axis coordinate of center point

An example of circular interpolation is shown below.

NC Code Example:	
<pre>N8% N9G90X0Y0Z-.1;SET START POINT N10G02X1Z0I.5J0F2;CLOCKWISE TO X1,Y0,Z-.1</pre>	
Code	Explanation
N8 %	Sets incremental arc center mode.
N9G90X0Y0Z-.1;SET START POINT	The first line defines the starting point and sets all coordinates, except for arc centers, to absolute mode.

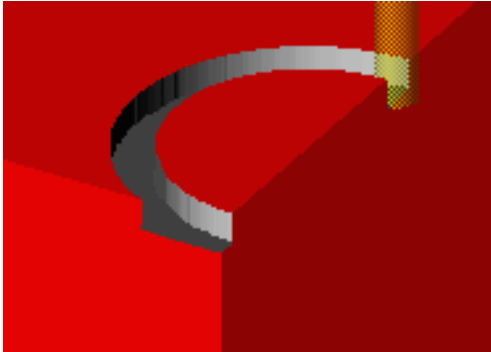
<p>N10G02X1Z-.10I.5J0F2; CLOCKWISE TO X1,Y0,Z-.1</p>	The second line defines the end point and the center point.	
	N10	The line sequence number is 10
	G02	The tool will proceed in a clockwise direction from the starting point to specified (X, Z) coordinates; center point of arc is specified by (I,K) coordinates
	X1	X axis coordinate of end point to increase by 1 to X1
	Z-.10	Z axis coordinate of end point to stay Z-.1
	I.5	I coordinate of center point of arc = 0.5 (relative to start point)
	J0	J coordinate of center point of arc = 0 (relative to start point)
	F2	Feed rate is 2 inches per minute
Example Motion	<p>Assuming the start point is X0, Y0, Z-.1, the tool path generated by the preceding lines would be as below.</p> 	

9.3. CIRCULAR INTERPOLATION PROGRAMMING IN OTHER PLANES

Circular interpolation in the XY plane is presented in 9.2 Circular Interpolation Programming in the XY Plane, pg. 130.

Circular interpolation can be performed in the XZ and YZ planes too, though this is rarely done when writing part programs manually. CAM systems may generate part programs that use circular interpolation in these planes for generating surfaces of revolution.

The following codes are used to select the plane for circular interpolation:

Info Table: Selecting a Plane for Circular Interpolation			
Code	Selects Plane	Arc Center Coordinates Specification	
G17	XY	I for the X axis, J for the Y axis	
G18	XZ	I for the X axis, K for the Z axis	

G19	YZ	J for the Y axis, K for the Z axis	
-----	----	------------------------------------	--

An example of circular interpolation in the XZ plane is shown below.

NC Code Example: N9X0Z0 N10G90G18G03X0Z1I0K.5F2															
Code	Explanation														
N9X0Z0	Sets initial position to X0Z0.														
N10G90G18G03X0Z1I0K.5F2	<table border="1"> <tr> <td>N10</td> <td>The line sequence number is 10</td> </tr> <tr> <td>G90</td> <td>Indicates absolute coordinates are used to define tool position.</td> </tr> <tr> <td>G18</td> <td>Selects the XZ plane for circular interpolation.</td> </tr> <tr> <td>G03</td> <td>Moves tool along circular path in counterclockwise direction.</td> </tr> <tr> <td>X0Z1</td> <td>Sets the final destination point for the tool to X0Z1.</td> </tr> <tr> <td>I0K.5</td> <td>Sets the incremental location of the center point of the curvature of motion.</td> </tr> <tr> <td>F2</td> <td>Feed rate is 2 inches per minute</td> </tr> </table>	N10	The line sequence number is 10	G90	Indicates absolute coordinates are used to define tool position.	G18	Selects the XZ plane for circular interpolation.	G03	Moves tool along circular path in counterclockwise direction.	X0Z1	Sets the final destination point for the tool to X0Z1.	I0K.5	Sets the incremental location of the center point of the curvature of motion.	F2	Feed rate is 2 inches per minute
	N10	The line sequence number is 10													
	G90	Indicates absolute coordinates are used to define tool position.													
	G18	Selects the XZ plane for circular interpolation.													
	G03	Moves tool along circular path in counterclockwise direction.													
	X0Z1	Sets the final destination point for the tool to X0Z1.													
	I0K.5	Sets the incremental location of the center point of the curvature of motion.													
F2	Feed rate is 2 inches per minute														

9.4. RAPID TRAVERSE PROGRAMMING

On the ProMill milling center, the rapid traverse code (G00) moves the tool at the maximum available feed rate (30 ipm) to the specified coordinates. Rapid traverse is often used to reposition the tool before ending a program, or in preparation for the next cut.

	<p>The tool should not be engaged in a cutting operation while traversing to a new location!</p>
---	--

Rapid traverse can be used for all tool positioning motions. This will reduce the run time for the part program. The G00 code remains in effect until linear (G01) or circular (G02, G03) interpolation is again specified. Linear or circular interpolation resumes at the feed rate last specified prior to the rapid traverse motion(s) unless a new feed rate is specified.

Rapid traverse is not affected by the feed rate scale factor. If all the positioning motions are performed in rapid traverse mode (G00) and all the cutting motions are performed in linear (G01) or circular interpolation (G02, G03) modes, cutting rates can be adjusted up or down using the feed rate scale factor without affecting rapid traverse motions.

An example of the use of rapid traverse is shown below.

NC Code Example: G90G01X1F2; MOVE IN A STRAIGHT LINE TO X = 1 AT 2 IPM G00X2; RAPID TRAVERSE TO X=2 X3; RAPID TRAVERSE TO X=3 G01X4; MOVE IN A STRAIGHT LINE TO X=4 AT 2 IPM	
Code	Explanation
G90G01X1F2; MOVE IN A STRAIGHT LINE TO X = 1 AT 2 IPM	G90 Sets absolute coordinates
	G0X1 Moves the tool to position X = 1, using linear interpolation.
	F2 Sets the feed rate to 2 inches per minute.
G00X2; RAPID TRAVERSE TO X=2	Specifies rapid traverse (G00) to position X = 2.
X3; RAPID TRAVERSE TO X=3	Moves tool to position X = 3. Rapid traverse mode is still active.
G01X4; MOVE IN A STRAIGHT LINE TO X=4 AT 2 IPM	G01 Turns off rapid traverse mode and engages linear interpolation.
	X4 Moves the tool to position X=4.

9.5. HELICAL INTERPOLATION PROGRAMMING

Helical interpolation is performed when the axis not used in circular interpolation is commanded to move. For example (assuming a start point of 0,0,0):

```
N10G90G03X0Y1Z1I0J.5F2
```

This block would cause the Z axis to move at a constant feed to Z1 while the X and Y axes move in a circular path, resulting in a helical motion. Helical interpolation works with a circular motion on the XZ and YZ planes as well.

An example of the use of helical interpolation is shown below.

NC Code Example: %; Sets incremental arc centers G90M03S1500 G0X0Y0Z0.070 G0X2Y2 G1Z-0.5F10 G02X0Y2Z0I-1J0F10 M02	
Code	Explanation

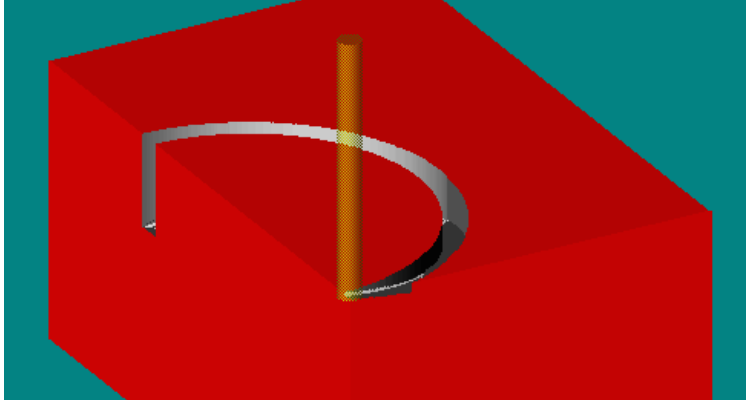
G02X0Y2Z0I-1J0F10	G02	The tool will proceed in a clockwise direction from the starting point to specified (X, Z) coordinates; center point of arc is specified by (I,K) coordinates
	X0Y2	Specifies the coordinates of the end point of the circular interpolation in the XY plane.
	Z	Specifies the Z coordinate of the tool after the circular interpolation ends.
	I-1J0	Specifies the coordinates of the center of circular interpolation.
	F10	Sets the feed rate to 10 inches per minute.
Example Motion	<p>The example program generates a cut as shown. Note that the arc is machined in the XY axis, but that the Z (vertical) coordinate of the end point is higher than the Z coordinate of the start point.</p> 	

9.6. CANNED CYCLE PROGRAMMING

Canned cycle commands allow you to perform many operations by specifying a small number of codes. They are typically used for repetitive operations to reduce the amount of data required in an NC program. Canned cycle codes are retained until superseded in the program by another canned cycle code.

The table below lists all canned cycles supported by the ProMill 8000 and its control software.

Info Table: Supported Canned Cycles			
Code	Explanation	Section	Page
G81	Straight drilling	9.6.2	136
G83	Peck drilling		
G82	Straight drilling with a dwell	9.6.3	138
G84	Thread tapping	9.6.4	139
G85	Boring	9.6.5	139

G86	Straight drilling with spindle stop	9.6.6	140
G89	Boring with dwell	9.6.7	141

The G80 command is used to cancel all of the canned cycles:

Info Table: Additional Canned Cycle Codes			
Code	Explanation	Section	Page
G80	Canned cycle cancel	9.6.1	136

The following codes are used within canned cycle codes.

Info Table: Codes Used in Conjunction with Canned Cycles	
Code	Explanation
G98	Rapid to initial position after canned cycle complete; this is the system default.
G99	Rapid to point R after canned cycle complete.
K	Specifies the number of repeats. The default is 1. When K=0, drilling data is stored.
P	Specifies the length of dwell time in seconds.
Q	Specifies the depth of cut. In peck drilling each peck uses the same Q value. The Q value is always positive. If a negative value is specified it is converted to a positive value.
R	Used for specifying a starting reference point for peck drilling. The point can be at the material surface or at another reference point.

9.6.1. G80: Cancelling a Canned Cycle

Use the G80 code to cancel a canned cycle. This code cancels the currently running canned cycle and resumes normal operation. All other milling data is canceled as well.

You can also cancel canned cycles by using a G00 or G01 code, as a G80 code is automatically performed as part of G00 and G01.

9.6.2. G81 & G83: Straight and Peck Drilling

The G81 code performs straight drilling operations. G83 is used for peck drilling.

The R code is used to specify a Z axis reference point for peck drilling. The point can be at the material surface or at another reference point. By specifying an R value of zero, the tool will return to the initial point after drilling to point Z.

The G98 code is the default for rapid movement to the initial point, or you could also use G99 to rapid to point R. We placed both rapid return codes in the sample below to show how they should be placed in the program.

A typical use of the G81 and G83 codes is shown in the following example.

NC Code Example:		
G0X1Y1Z1;RAPID TO INITIAL POINT (1,1,1)		
G98G81Z-.1R.1F2;CENTER DRILL TO DEPTH OF Z-.1 FROM Z.1 FEED 2, RAPID TO INITIAL POINTG99G83Z-.5R0Q.1F3;PECK DRILL TO Z-.5 FROM Z0 EACH PECK .1, RAPID TO POINT R0		
G80;CANCEL CANNED CYCLE		
M2;END PROGRAM		
Code	Explanation	
G0X1Y1Z1;RAPID TO 1,1,1	Rapid motion to X1 Y1 Z1.	
G98G81Z-.1R.1F2;CENTER DRILL TO DEPTH OF Z-.1 FROM Z.1 FEED 2, RAPID TO INITIAL POINT	G81Z-.1R.1	Straight drill to Z-.1 (from Z.1)
	G98	Rapid back to Z1 after drilling
	F2	Feed rate = 2 inches/min
G99G83Z-.5R0Q.1F3;PECK DRILL TO Z-.5 FROM Z0 EACH PECK .1, RAPID TO POINT R	G83Z-.5	Peck drill to Z-.5 (from Z0)
	G99 R0	Retract to Z0 after completing canned cycle
	Q.1	Drill a maximum of 0.1 inch per peck.
	F3	Feed rate = 3 inches/min
G80	Cancel canned cycle.	
M2	End program.	

Example Motion

The straight drill cycle will result in motion as shown below.

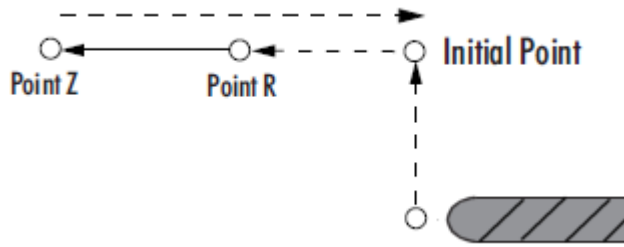

The peck drill cycle will result in motion as shown below.

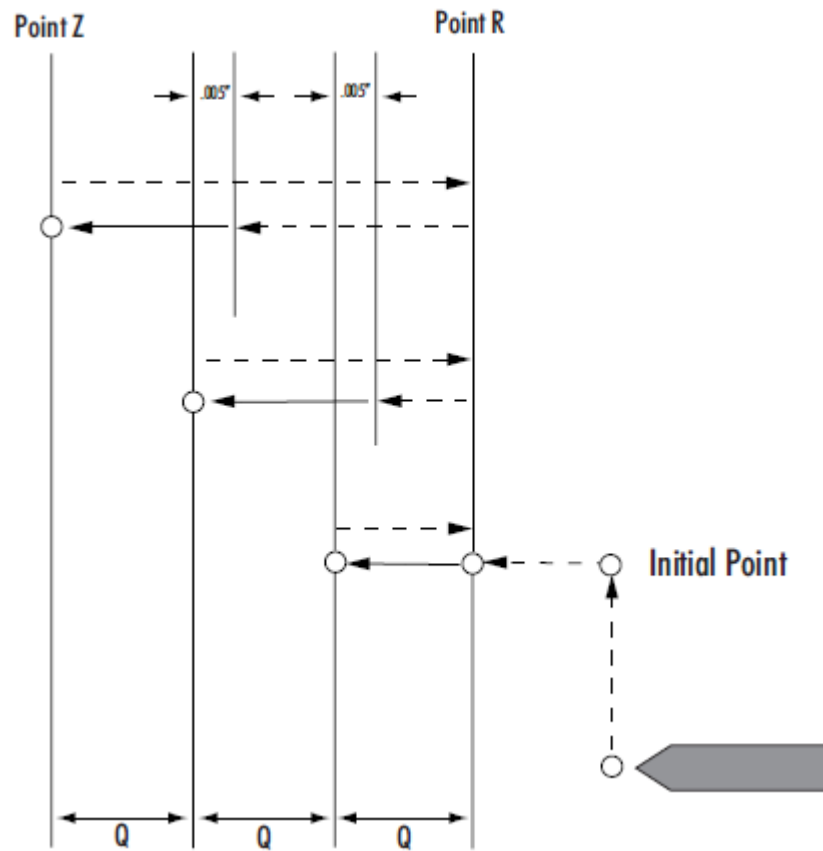

9.6.3. G82: Straight Drilling with Dwell

A G82 code works just like a G81 code (see 9.6.2 G81 & G83: Straight and Peck Drilling, pg. 136), except that it allows for a dwell (P code) at the bottom of the hole (point Z).

The use of the G82 code is shown in following example.

NC Code Example:

<p>G0X1Y1Z.1; RAPID TO 1,1,.1 G82G98Z-.5R0P5F2; DRILL TO DEPTH OF -.5, RAPID TO INITIAL POINT AFTER DWELL OF 5 SECONDS. G80; CANCEL CANNED CYCLE M2; END PROGRAM</p>													
Code	Explanation												
<p>G82G98Z-.5R0P5F2; DRILL TO DEPTH OF -.5, RAPID TO INITIAL POINT AFTER DWELL OF 5 SECONDS.</p>	<table border="1"> <tr> <td>G82</td> <td>Straight drill with dwell</td> </tr> <tr> <td>G98</td> <td>Rapid move to initial tool position after canned cycle complete.</td> </tr> <tr> <td>Z-.5</td> <td>Drill to depth of 0.5 inches</td> </tr> <tr> <td>R0</td> <td>Retract to Z0 after canned cycle complete.</td> </tr> <tr> <td>P5</td> <td>Dwell for 5 seconds at bottom of drilled hole.</td> </tr> <tr> <td>F2</td> <td>Feed rate of 2 inches per minute.</td> </tr> </table>	G82	Straight drill with dwell	G98	Rapid move to initial tool position after canned cycle complete.	Z-.5	Drill to depth of 0.5 inches	R0	Retract to Z0 after canned cycle complete.	P5	Dwell for 5 seconds at bottom of drilled hole.	F2	Feed rate of 2 inches per minute.
	G82	Straight drill with dwell											
	G98	Rapid move to initial tool position after canned cycle complete.											
	Z-.5	Drill to depth of 0.5 inches											
	R0	Retract to Z0 after canned cycle complete.											
	P5	Dwell for 5 seconds at bottom of drilled hole.											
F2	Feed rate of 2 inches per minute.												

9.6.4. G84: Thread Tapping

A G84 code is used for tapping threads. The tap reaches the specified depth and is then pulled out at a rate 1.6 times the rate of insertion (60% faster).

A tapping head with a reversing mechanism is required when using a G84 code.

The use of the G84 code is shown in following example.

<p>NC Code Example: G0X1Y1Z.1; RAPID TO 1, 1, .1 G84G98Z-.5R0F2; TAP TO DEPTH OF -.5, RAPID TO INITIAL POINT G80; CANCEL CANNED CYCLE M2; END PROGRAM</p>											
Code	Explanation										
<p>G84G98Z-.5R0F2; TAP TO DEPTH OF -.5, RAPID TO INITIAL POINT</p>	<table border="1"> <tr> <td>G84</td> <td>Start Thread Tapping cycle</td> </tr> <tr> <td>G98</td> <td>Rapid move to initial tool position after canned cycle complete.</td> </tr> <tr> <td>Z-.5</td> <td>Drill to depth of 0.5 inches</td> </tr> <tr> <td>R0</td> <td>Retract to Z0 after canned cycle complete.</td> </tr> <tr> <td>F2</td> <td>Feed rate of 2 inches per minute.</td> </tr> </table>	G84	Start Thread Tapping cycle	G98	Rapid move to initial tool position after canned cycle complete.	Z-.5	Drill to depth of 0.5 inches	R0	Retract to Z0 after canned cycle complete.	F2	Feed rate of 2 inches per minute.
	G84	Start Thread Tapping cycle									
	G98	Rapid move to initial tool position after canned cycle complete.									
	Z-.5	Drill to depth of 0.5 inches									
	R0	Retract to Z0 after canned cycle complete.									
	F2	Feed rate of 2 inches per minute.									

9.6.5. G85: Boring

The G85 code specifies a boring cycle. After the tool plunges, it retracts at the same feed to point R. This sometimes gives a better surface finish on the hole. The tool then rapids to the initial point.

The use of the G85 code is shown in following example.

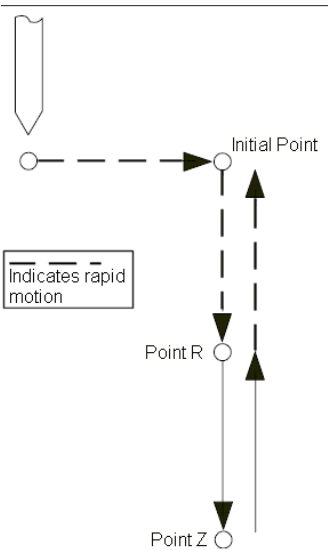
NC Code Example:											
G0X1Y1Z.1; RAPID TO 1, 1, .1											
G85G98Z-.5R0F2; BORE TO DEPTH OF -.5, RAPID TO INITIAL POINT FROM POINT R											
G80; CANCEL CANNED CYCLE											
M2; END PROGRAM											
Code	Explanation										
G85G98Z-.5R0F2; BORE TO DEPTH OF -.5, RAPID TO INITIAL POINT FROM POINT R	<table border="1"> <tr> <td>G85</td> <td>BORING CYCLE</td> </tr> <tr> <td>G98</td> <td>Rapid move to initial tool position after canned cycle complete.</td> </tr> <tr> <td>Z-.5</td> <td>Drill to depth of 0.5 inches</td> </tr> <tr> <td>R0</td> <td>Retract to Z0 after canned cycle complete.</td> </tr> <tr> <td>F2</td> <td>Feed rate of 2 inches per minute.</td> </tr> </table>	G85	BORING CYCLE	G98	Rapid move to initial tool position after canned cycle complete.	Z-.5	Drill to depth of 0.5 inches	R0	Retract to Z0 after canned cycle complete.	F2	Feed rate of 2 inches per minute.
G85	BORING CYCLE										
G98	Rapid move to initial tool position after canned cycle complete.										
Z-.5	Drill to depth of 0.5 inches										
R0	Retract to Z0 after canned cycle complete.										
F2	Feed rate of 2 inches per minute.										
Example Motion	<p>The tool path generated by the example code would be as below.</p> 										

9.6.6. G86: Straight Drilling with Spindle Stop

The G86 code is similar to the G82 code (see 9.6.3 G82: Straight Drilling with Dwell, pg. 138) except that the spindle rotation stops at the bottom of the hole. The dwell (optional) allows the spindle to come to a complete stop before the tool rapids back to the initial point.

An example of the use of the G86 code is shown below.

NC Code Example:		
G0X1Y1Z.1; RAPID TO 1, 1, .1		
G86G98Z-.5R0P5F2; DRILL TO DEPTH OF -.5, SHUT OF SPINDLE, RAPID TO INITIAL POINT AFTER DWELL OF FIVE SECONDS		
G80; CANCEL CANNED CYCLE		
M2; END PROGRAM		
Code	Explanation	
G86G98Z-.5R0P5F2; DRILL TO DEPTH OF -.5, SHUT OF SPINDLE, RAPID TO INITIAL POINT AFTER DWELL OF FIVE SECONDS	G86	Straight drilling, stop spindle rotation before retraction.
	G98	Rapid move to initial tool position after canned cycle complete.
	Z-.5	Drill to depth of 0.5 inches
	R0	Retract to Z0 after canned cycle complete.
	P5	Dwell at the bottom of the hole for 5 seconds, to allow spindle rotation to stop completely.
	F2	Feed rate of 2 inches per minute.

9.6.7. G89: Boring with Dwell

The G89 code is similar to the G85 code (see 9.6.7 G85: Boring with , pg. 141) except that it allows for a dwell at the bottom of the hole.

The use of the G89 code is shown in following example.

NC Code Example:

G0X1Y1Z.1; RAPID TO 1, 1, .1

G89G98Z-.5R0P5F2; BORE TO DEPTH OF -.5, PAUSE FOR 5 SECONDS, RAPID TO INITIAL POINT FROM POINT R

G80; CANCEL CANNED CYCLE

M2; END PROGRAM

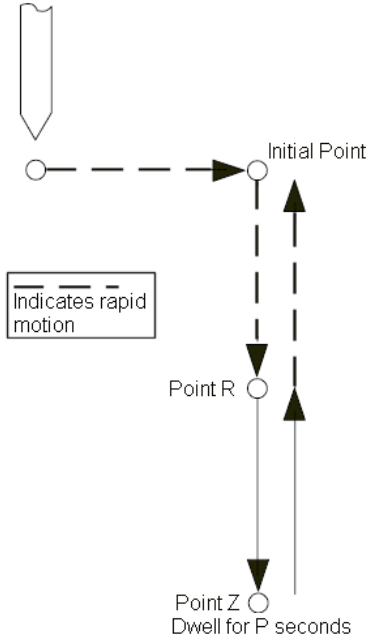
Code	Explanation												
<p>G89G98Z-.5R0P5F2; BORE TO DEPTH OF -.5, RAPID TO INITIAL POINT FROM POINT R</p>	<table border="1"> <tr> <td data-bbox="493 600 602 653">G89</td> <td data-bbox="602 600 1190 653">Boring cycle with dwell.</td> </tr> <tr> <td data-bbox="493 653 602 730">G98</td> <td data-bbox="602 653 1190 730">Rapid move to initial tool position after canned cycle complete.</td> </tr> <tr> <td data-bbox="493 730 602 783">Z-.5</td> <td data-bbox="602 730 1190 783">Drill to depth of 0.5 inches</td> </tr> <tr> <td data-bbox="493 783 602 835">P5</td> <td data-bbox="602 783 1190 835">Pause for five seconds at bottom of hole.</td> </tr> <tr> <td data-bbox="493 835 602 888">R0</td> <td data-bbox="602 835 1190 888">Retract to Z0 after canned cycle complete.</td> </tr> <tr> <td data-bbox="493 888 602 940">F2</td> <td data-bbox="602 888 1190 940">Feed rate of 2 inches per minute.</td> </tr> </table>	G89	Boring cycle with dwell.	G98	Rapid move to initial tool position after canned cycle complete.	Z-.5	Drill to depth of 0.5 inches	P5	Pause for five seconds at bottom of hole.	R0	Retract to Z0 after canned cycle complete.	F2	Feed rate of 2 inches per minute.
G89	Boring cycle with dwell.												
G98	Rapid move to initial tool position after canned cycle complete.												
Z-.5	Drill to depth of 0.5 inches												
P5	Pause for five seconds at bottom of hole.												
R0	Retract to Z0 after canned cycle complete.												
F2	Feed rate of 2 inches per minute.												
<p>Example Motion</p>	<p>The tool path generated by the example code would be as below.</p> 												

9.7. SUBPROGRAM PROGRAMMING

Subprograms are used to execute repetitive routines in an NC program. The subprogram is entered in the NC code only once, but can be called and run any number of times. This is especially useful if the milling operation you wish to repeat is lengthy or complex.

The NC codes used for sub-programming on the ProMill milling center are listed below.

Info Table: Sub-programming NC Codes	
Code	Description
M98	Call to subprogram.
M99	Return from subprogram.
P	The P code is used to reference the first line of the subprogram (which begins with an O code). The P code immediately follows an M98. The P code can also be used with an M99 code to specify the line number in the main program to be run next.
L	The L code is used as a loop counter when used in sub-programming. The computer executes the subprogram the number of times set by the L code. For instance, if the code is L5, the subprogram is executed five times. After the fifth cycle, the program will not restart the subprogram but will instead continue to the next step in the program. (Optional)
O	The O code replaces the N code on the first line of a subprogram.

The general program flow when using a subprogram is illustrated in this table.

Subprogram Flow	
No.	Description
1	An M98 and P code located in the main program call the subprogram. The P code specifies which subprogram to run. Each subprogram is labeled with an O code instead of an N code.
2	The main program is interrupted, and the subprogram begins to run.
3	An M99 code in the subprogram ends the subprogram. The main program recommences from the point at which it was interrupted.

Subprogram calls can also be nested within other subprogram calls. This means that while a subprogram is being executed, it can call another subprogram. The default number of levels that subprograms can be nested is 20 levels deep.

The sample subprogram below makes a series of light chamfered grooves. It is set up for stock with a 0.75" diameter and 2" length so you should use a piece slightly longer than that, say 0.75" X 2.5", if you plan to test it.

Note that the file uses absolute programming in the main program and incremental programming in the subprogram. This makes it necessary to use the G90 code after the subprogram is executed to allow motion back to the start point.

NC Code Example:

```
G05
M03 S1000
;SUBPROGRAMMING SAMPLE
```

```
;USE 7.25 X 3.00 STOCK TO VERIFY
G00 X1 Y1 Z.1 ;RAPID TO 1, 1, .1
M98 P1000 L4 ;RUN SUBPROGRAM 4 TIMES
G90 G00 X0 Y0 Z.1
M2 ;END OF MAIN PROGRAM
O1000 ;SUBPROGRAM TO MILL SQUARE AND MOVE
G90 G01 Z-.1 F2 ;PLUNGE AT CURRENT LOCATION
G91 ;INCREMENTAL COORDINATES
X1 F5 ;FIRST MOVE, FEED 5
Y1 ;SECOND MOVE
X-1 ;THIRD MOVE
Y-1 ;FOURTH MOVE
G90 G0 Z.1 ;RAPID ABOVE WORKPIECE
G91 G00 X1.5 ;RAPID TO START OF NEXT SQUARE
M99 ;RETURN FROM SUBPROGRAM
```

Note: Only selected lines are explained below.

Code	Explanation				
M98P1000L4;CALLS SUBPROGRAM 1000 AND EXECUTES IT 4 TIMES	<table border="1" data-bbox="560 926 1398 1031"> <tr> <td data-bbox="560 926 837 980">M98P1000</td> <td data-bbox="837 926 1398 980">Call the subprogram whose O code is O1000.</td> </tr> <tr> <td data-bbox="560 980 837 1031">L4</td> <td data-bbox="837 980 1398 1031">Run the subprogram 4 times.</td> </tr> </table>	M98P1000	Call the subprogram whose O code is O1000.	L4	Run the subprogram 4 times.
M98P1000	Call the subprogram whose O code is O1000.				
L4	Run the subprogram 4 times.				
O1000; SUBPROGRAM TO MILL SQUARE AND MOVE	Indicates the start of subprogram 1000.				
M99; RETURN FROM SUBPROGRAM	Indicates the end of the subprogram.				

10. Multiple Tool Programming

Using multiple tool programs provides the advanced user with the ability to create more complex parts on the milling center.

If fitted with the optional automatic tool changer (ATC), the ProMill 8000 will automatically change tools during program execution. If the ATC is not fitted, the control software will prompt the user to manually change tools as required during program execution.

This section presents instructions for writing NC code using multiple tools.

There are six basic steps in setting up the milling center for multiple tool operation:

Procedure Outline: Multiple Tool Programming			
No.	Description	Section	Page
1	In the control software, specify the tools being used.	10.1	146
2	In the control software, specify how the tools are configured in the automatic tool changer (if fitted).	10.2	146
3	Write the NC program.	10.3	147
4	Define and configure one tool as a reference tool.	10.4	148
5	Set the offsets for the other tools, relative to the reference tool.	10.5	149
6	Test the NC program.	10.6	152

This section also presents a tutorial on multiple tool programming.

Section Contents: Multiple Tool Programming		
10.7	Tutorial: Running a Multi-tool Program	153

10.1. SPECIFYING THE TOOLS

For the control software to successfully run a multi-tool program, you must specify the tools being used. Follow the procedure below to specify the tools.

Procedure: Specifying the Tools

1. Click **Tools | Setup Library** to access the Setup Tool Library.
2. Click a tool in the left panel to select it, and enter the relevant settings in the fields on the right.
3. Click **OK** to save changes made and close the window.

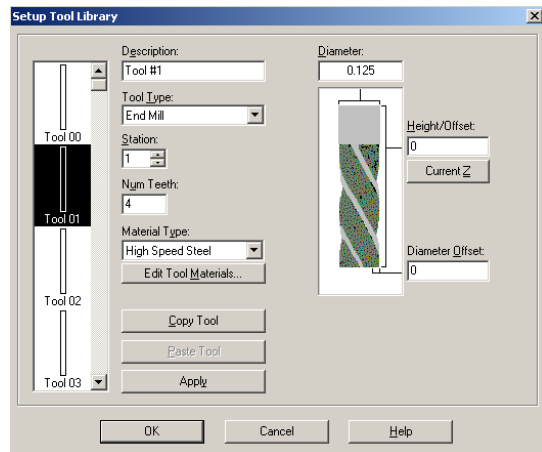

10.2. CONFIGURING THE ATC



Take Note

This section is only applicable if the optional automatic tool changer is installed.

After having specified the tools used, you must specify how they are arranged in the automatic tool changer (ATC).

Follow the procedure below to configure the ATC.

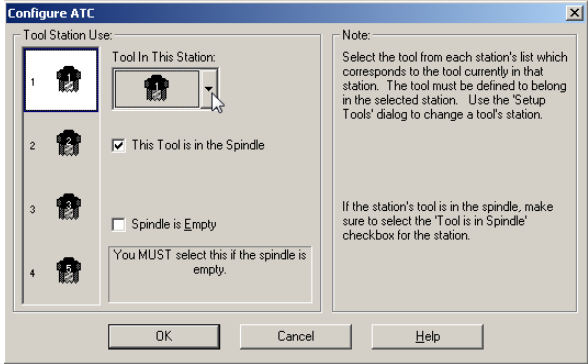
Procedure: Configuring the ATC	
<ol style="list-style-type: none"> 1. Click Tools Configure ATC to access the Configure ATC window. The Tool Station Use area shows which tool is currently present in each of the four tool stations. 2. To specify a different tool at a station, click the station position in the Tool Station Use area, and then select the tool at that position from the Tool in This Station menu. 3. Click OK to save changes made and close the window. 	

10.3. WRITING AN NC PROGRAM FOR MULTIPLE TOOLS

The T code is used in the NC program to offset the cutter so that the NC program becomes independent of the cutter length. The offset for each tool is specified in the Setup Tool Library window. This means you can replace a worn tool with a tool of a different length without changing the NC program: you need only enter a new offset.

The T code can be located anywhere within the block of NC code, but is normally placed after any of the G codes.

Use the M06 code with a T code for multiple tool operations. If you do not use an M06 code, the machine will use the tool currently selected in the ATC and interpret the T code as an offset reference only.

When used with an M06, the T code indicates, by number, which tool and which offset to use. For example, M06T2 tells the machine to insert Tool #02 into the spindle and use the offset specified for Tool #02.



Safety

The tool must be retracted from the workpiece before performing a tool change.

The tool that is shown in the Machine Info window is the default tool for the start of a program. The control software assumes that tool is in use unless another tool is specified with a T code. Once a tool is specified, any X, Y and Z coordinates are applied to that tool until another T code is encountered in the NC program.

In the example below, the Machine Info window shows that Tool #01 is in use. Unless the program includes a T code, the offset specified for Tool #01 in the Setup Tool Library will be used throughout.

Machine Info	
Tool	01
Pass	000

The code below demonstrates the use of T and M06 codes for changing tools.

Example Code: Tool Change

```
N7 ; Tool #1: 'End Mill'
N8 ; Tool #2: 'Ball Mill'
N9 G70 ; Inch Units
N10 M03 S1500
N11 M06 T01 ; Toolchange to Tool #01
N12 G04 F5 ; Dwell 5 Seconds
N13 M06 T02 ; Toolchange to Tool #02
```

Code	Explanation
N7 ; Tool #1: 'End Mill' N8 ; Tool #2: 'Ball Mill'	Comment lines describing the two tools in use.
N9 G70 ; Inch Units	Set units to inches.
N10 M03 S1500	Turn on the spindle, with speed of 1500RPM.
N11 M06 T01 ; Toolchange to Tool #01	Insert Tool #01 into the spindle and use its offset.
N12 G04 F5 ; Dwell 5 Seconds	Wait for 5 seconds
N13 M06 T02 ; Toolchange to Tool #02	Return Tool #01 and insert Tool #02 into the spindle and use its offset.

10.4. ESTABLISHING THE REFERENCE TOOL

When using multiple tools, a reference tool, normally Tool #01, is set to zero for the X, Y and Z axes. This establishes a reference tool position which is used as a reference point for additional tools.

In this procedure, Tool #01 is used as the reference tool and Tool #02 as the additional tool.

Procedure: Establishing the Reference Tool

1. Decide on a reference point. A reference point is a point on the workpiece, or on a gauge, to which you will jog the tip of each tool.
2. Insert the workpiece or gauge to be used for the reference point.
3. Ensure that Tool #01 is positioned in the spindle.
4. Close the safety door.
5. Open the Jog Control Panel if not already open. To do so, click **View | Jog Control** in the Main Menu.
6. If using a workpiece for the reference point, turn the spindle on, setting it to its minimum speed. If using a gauge, ensure that the spindle is off.

7. Jog the tool slowly until it just touches the reference point. Follow the guidelines below.
 - a. Use Continuous mode (selected in the Step Zone area of the Jog Control panel) to move the tool towards the reference point, but stop motion before the tool is in range of touching the reference point.

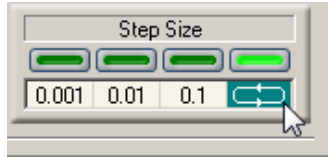

- b. Once the tool is near the reference point, switch to Step mode, using a small step size. Jog the tool, step by step, until it touches the reference point.



8. Click **Setup | Set Position** the Main Menu. The Set Position window opens.

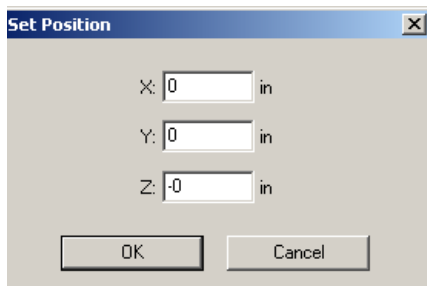

9. Set X, Y and Z to 0.
10. Click **OK**.

Tool #1 is now established as the reference tool.

10.5. SETTING TOOL OFFSETS

Once the reference tool is established, you can define offsets for the other tools to be used. You will first determine what the Z offset setting should be. You will then enter that offset into the control software.



Take Note

If using an automatic tool changer, do not remove the tools from their tool holders after establishing the reference tool and setting the offsets of other tools. Doing so will reduce the accuracy of the offsets.

Follow this procedure to set tool offsets.

Procedure: Setting Tool Offsets

1. Establish the reference tool as described in the previous section, 10.4 Establishing the Reference Tool, pg. 148.
2. Jog the tool to a safe distance from the workpiece or gauge to prevent a collision when changing the tool.

Click **Tools** | **Select Tool**

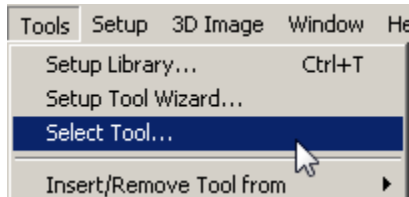

3. Select Tool #2 from the Tool list, and click **Select Tool**.

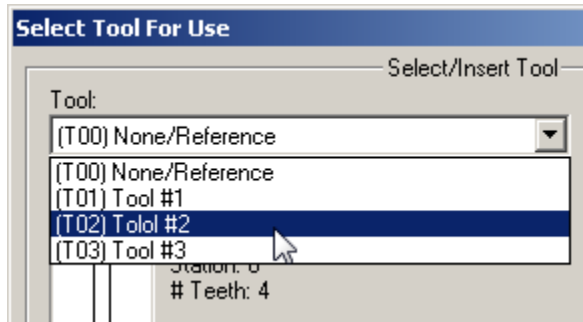

4. If an ATC is fitted, the ProMill will now automatically replace the current tool in the spindle and load tool #2.

If working without an ATC, load tool #2 into the spindle manually. See 6 Installing a Tool, pg. 73.

5. Jog the tool slowly until it just touches the reference point. As in the previous section, use Continuous mode to approach the reference point, and Step mode to jog the tool until it touches the reference point.
6. Take note of the Z coordinate displayed in the Position Window. This is the offset value for the selected tool.

Actual Position	
	Absolute
X	-0.1367 in
Y	-0.3551 in
Z	-0.0844 in

7. Click **Tools** | **Setup Library** in the Main Menu.

8. Select Tool #02 from the list at the left.

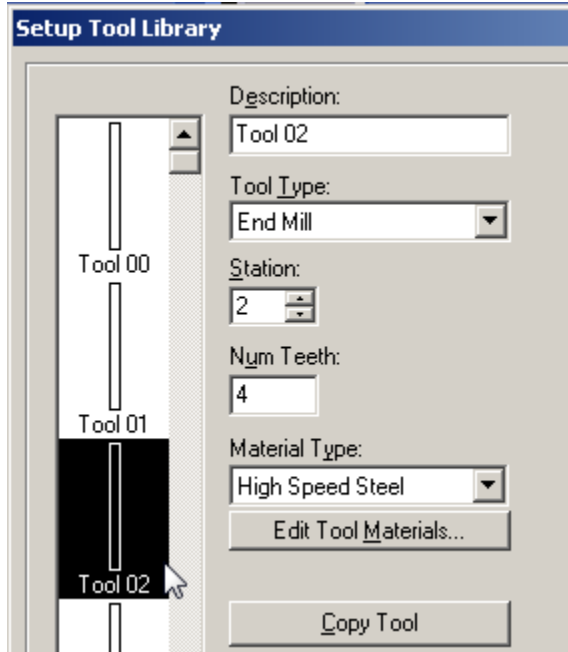

9. Click Use Current Z.

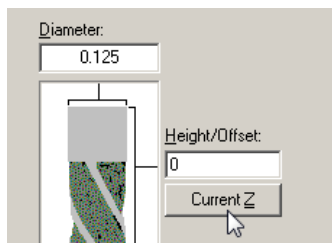

The offset value is automatically filled with the position value found in step 6.

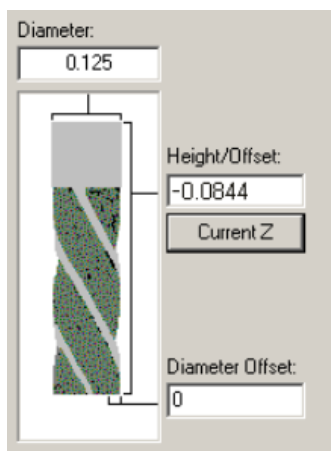

10. Click **OK** to save the changes and close the window.

The offset for Tool #02 is now defined.

11. Repeat this procedure for Tools #03 and #04, if they will be used.

10.6. TESTING THE MULTI-TOOL PROGRAM

As for any NC program, a multi-tool NC program must be tested by performing a dry run (running the program without a workpiece in place), before running the program with a workpiece in place.



Safety

Always complete the Safety Checklist (see 1.2 Safety Checklist, pg. 5) before running a program on the milling center.

Throughout the test, be prepared to press the emergency stop button on the milling center in case of a tool crash.

Follow this procedure to perform a dry run on a multi-tool program.

Procedure: Testing a multi-tool program

1. If using an ATC, ensure that all tools are in their respective positions in the ATC.
2. Close the safety door, put on your safety goggles, and complete the Safety Checklist (see 1.2 Safety Checklist, pg. 5).
3. Click **Program | Run/Continue** in the Main Menu, or click the Run button  in the Standard Toolbar.

The Run Program window is displayed.

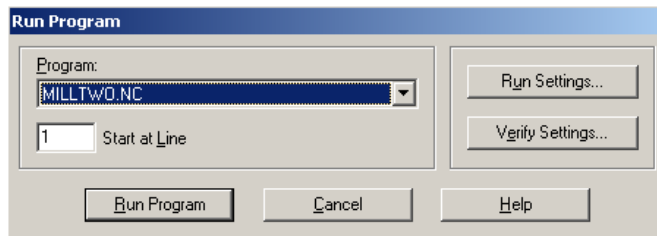

4. Ensure that *Start at Line* is set to 1.
5. Click **Run Program**.
6. Throughout the test, be prepared to press the Emergency Stop button on the machining center in case of a tool crash.
7. Observe the milling procedure, noting any corrections to be made in the NC program.

After successfully testing the program in a dry run, you can then run the program with a workpiece in place.

10.7. TUTORIAL: RUNNING A MULTI-TOOL PROGRAM

This section provides detailed instructions for milling a sample part using multiple tools, covering the entire process from NC program verification through to milling a complete part on the ProMill 8000. The tutorial will follow the procedure below.

Procedure Outline: Tutorial		
Description	Section	Page
Review safety procedures.	10.7.1	153
Prepare required tools and materials.	10.7.2	153
Open the sample NC file.	10.7.3	153
Define the tools to be used.	10.7.4	154
Configure the automatic tool changer (if fitted).	10.7.5	154
Configure the Verify settings.	10.7.6	154
Verify the program.	10.7.7	155
Establish the reference tool.	10.7.8	156
Set the offsets for the other tools.	10.7.9	156
Test the program without a workpiece in place.	10.7.10	157
Mount the workpiece.	10.7.11	157
Run the program.	10.7.12	157

10.7.1. Reviewing Safety Procedures

Like any other power tool, the ProMill Milling Center is a potentially dangerous machine if operated in a careless manner. The importance of safely operating the ProMill Milling Center, including the need for protection against personal injury and the prevention of damage to the equipment, cannot be stressed enough.



Safety

Ensure that you are familiar with all safety guidelines in 1 Safety Guidelines, pg. 1, before continuing.

10.7.2. Preparing Tools and Materials

For this tutorial you will require the following:

Tools and Materials List: Tutorial

One 3" (length) x 2" (width) x 1.5" (height) block of machinable brass, aluminum, Delrin, or wax

10.7.3. Opening the Sample NC File

Open the sample file *MILLTWO.nc*.

For instructions on opening NC files, see 5.5 Opening an NC File, pg. 62.

10.7.4. Defining the Tools

The sample NC program uses three tools to turn the part. These tools must be defined in the **Setup Tool Library**.

For instructions on defining tools, see 10.1 Specifying the Tools, pg. 146.

Specify the two tools as detailed in the table below.

Tool Specifications		
	Tool 1	Tool 2
Description	.25" End Mill	.125" End Mill
Tool Type	End Mill	End Mill
Station	1	2
Material Type	High Speed Steel	High Speed Steel
Diameter	.25	.125
Num Teeth	4	4

10.7.5. Configuring the Tool Changer

Once the tools are defined, you must configure the tool changer, specifying which tool is present in each of the changer's stations.

For instructions on configuring the tool changer, see 10.2 Configuring the ATC, pg. 10.2.

Configure the tool ATC as detailed in the table below.

ATC Configuration				
	Tool Station 1	Tool Station 2	Tool Station 3	Tool Station 4
Tool	Tool 01#	Tool #02	-	-

10.7.6. Configuring the Verify Settings

Before running the NC program on the milling center, it must be tested in the Verify window of the control software.

The Verify settings must be configured correctly so that the verification process will test the NC program accurately.

For instructions on configuring the Verify settings, see 5.6.3 Configuring Verify Settings, pg. 68.

For an example on configuring the Verify settings, see 7.5 Configuring the Verify Settings, pg. 80.

Make the following settings in the Verify Program window.

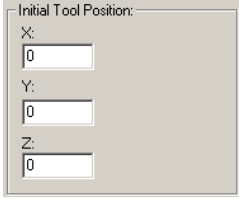
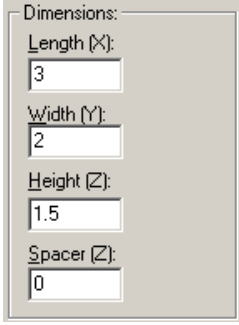
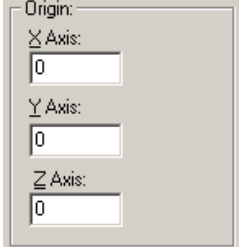
Verify Settings		
	Setting	
Initial Tool Position	X = 0 Y = 0 Z = 0	 <p>Initial Tool Position: X: <input type="text" value="0"/> Y: <input type="text" value="0"/> Z: <input type="text" value="0"/></p>
Stock Dimensions	X = 3.0 Y = 2.0 Z = 1.5	 <p>Dimensions: Length (X): <input type="text" value="3"/> Width (Y): <input type="text" value="2"/> Height (Z): <input type="text" value="1.5"/> Spacer (Z): <input type="text" value="0"/></p>
Origin	X = 0 Y = 0 Z = 0	 <p>Origin: X Axis: <input type="text" value="0"/> Y Axis: <input type="text" value="0"/> Z Axis: <input type="text" value="0"/></p>

10.7.7. Verifying the Program

Tool path verification allows you to check for programming errors before actually running the part program on the Milling Center.

For an example of verifying a program, see 7.7 Verifying the Program, pg. 86.

The Verify window should output a part as shown below.

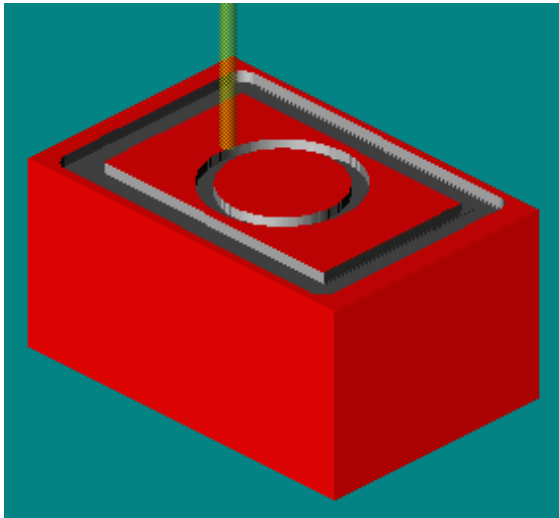

10.7.8. Establishing the Reference Tool

When using multiple tools, a reference tool, normally Tool #01, is set to zero for the Z axis. This establishes a reference tool position which is used as a reference point for additional tools.

For instructions on establishing a reference tool, see 10.4 Establishing the Reference Tool, pg. 148.

Set the reference point on the face, at the front left corner of the workpiece (the end of the stock farthest from the chuck and at the edge of the stock). You can also select another point on the workpiece as a reference point, as shown in the illustration below.

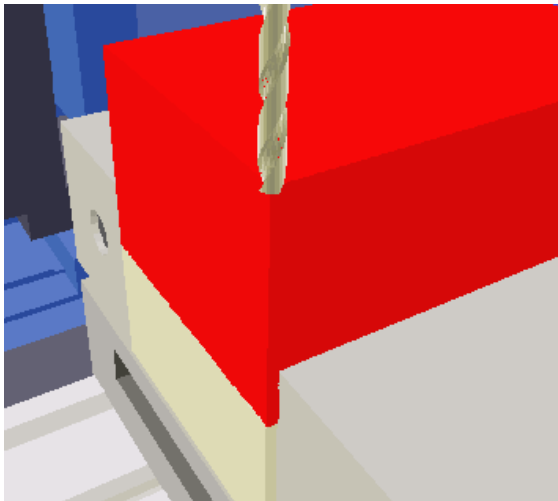

10.7.9. Setting Tool Offsets

The second tool for this program is an 1/8" end mill which will be used to create a circle. You must set the offsets for this tool using the same reference point used for establishing the reference tool.

For instruction on setting tool offsets, see 10.5 Setting Tool Offsets, pg. 149.

10.7.10. Testing the Program

As for any NC program, a multi-tool NC program must be tested by performing a dry run (running the program without a workpiece in place), before running the program with a workpiece in place.

For instructions on performing a dry run, see 10.6 Testing the Multi-tool Program, pg. 152.

10.7.11. Mount the Workpiece

Once you have performed a successful dry run, prepare for actual milling by mounting the workpiece.

For instructions on mounting the workpiece, see 7.9 Mounting the Workpiece, pg. 88.

10.7.12. Running the Program

Now that the program has been checked in the Verify window and by performing a dry run, the program can finally be run on an actual workpiece.

For instructions on running the program, see 7.12 Running the Program, pg. 94.

11. An Introduction to CNC Milling

This section provides a basic introduction to CNC milling. The following topics are covered.

Section Contents: An Introduction to CNC Milling		
Section	Name	Page
11.1	Understanding Coordinate Systems	158
11.2	Setting Spindle Speeds	161
11.3	Setting Feed Rate and Depth of Cut	162
11.4	Selecting Lubricants and Coolants	163
11.5	Tool Types	163
11.6	Sharpening the Tools	165

11.1. UNDERSTANDING COORDINATE SYSTEMS

To understand how the coordinate system works in milling, the following concepts must be explained:

Section Contents: Understanding Coordinate Systems		
Section	Name	Page
11.1.1	X, Y and Z Axes	158
11.1.2	Machine Home Position	159
11.1.3	The Work Coordinates	159
11.1.4	Multiple Coordinate Systems	160

11.1.1. X, Y and Z Axes

The ProMill has three axis motors. These motors control the movement of the cutting tool and the cross-slide as follows:

- The Z-axis motor moves the spindle up and down, or in and out of the workpiece.
- The X-axis motor moves the cross-slide left and right beneath the tool.
- The Y-axis motor moves the cross-slide in and out beneath the tool, or toward and away from the vertical column.

In NC programming, the programs are written as though the workpiece is stationary and the tool is moving.

The location and direction of the axes are shown in the graphic below.

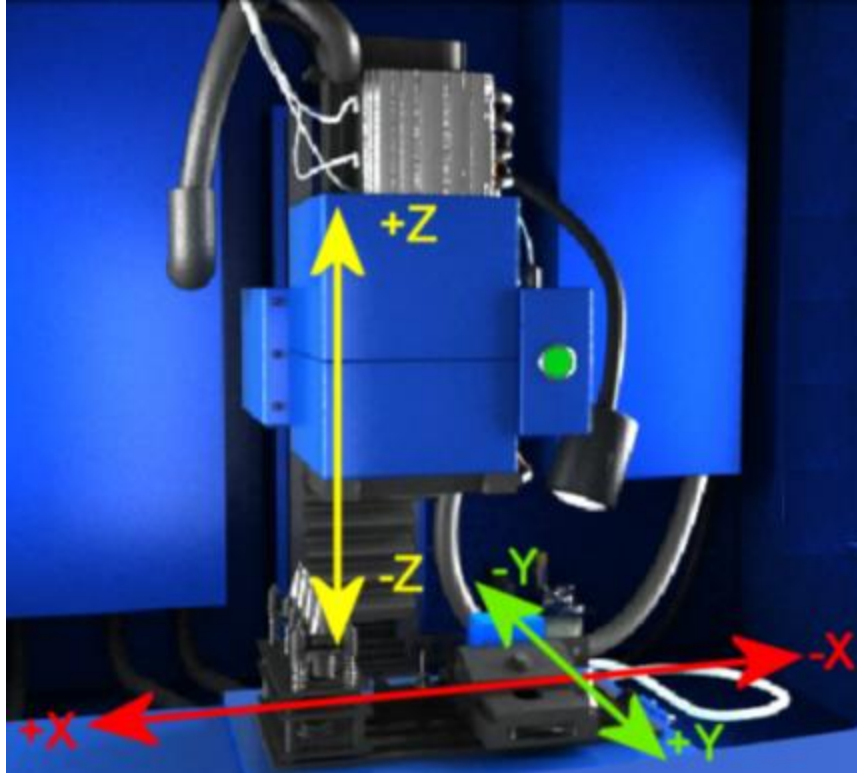

11.1.2. Machine Home Position

The machine home is a specific and factory-set location to which the tool can be sent through the control software. The machine uses the home position as a reference point for all operations. If the machine is not homed, it cannot accurately locate the workpiece on the cross slide.

The machine home location is located as follows:

Info Table: Machine Home Position Location	
Axis	Location
X	Near the maximum positive position
Y	Near the maximum positive position
Z	Near the maximum positive position

When moving to its home position, the tool first moves up along the Z axis to reduce the chance of impact during the homing sequence.

The machine is homed by clicking **Setup | Set/Check Home** in the Main Menu.

It is advisable to home the machine before running a program on it.

11.1.3. The Work Coordinates

The location of the tool at any time can be described by its position along the X, Y and Z axes. However, the origin point (0,0,0) is not factory-set and can be defined as any point within the work area.

The user defines the point of origin, and the machine will measure X, Y, and Z coordinates from that point. The machine home position is almost never used as the point of origin, so the coordinates of the home position are seldom (0,0,0).

The point of origin can be located anywhere on the workpiece, but is often set to the front, top left corner of the workpiece, as shown below.



To define the origin as illustrated above, jog the tool to the front, top left corner and define the coordinates as (0,0,0).

11.1.4. Multiple Coordinate Systems

For more advanced operations, such as milling multiple parts on the same piece of stock, set up multiple coordinate systems.

For information on how coordinate systems are activated in an NC program, see 8.4.6.7 The Coordinate System Group, pg. 105.

For example, if you have an NC program that machines a complex shape and you want to machine that shape in multiple places on the same part, use the following procedure.

Procedure: Using Multiple Coordinate Systems

1. Move the tool tip to the work coordinate point of origin (0,0,0) using the **Set Position** command from the **Setup** menu.
2. Select the **Coordinate Systems** command from the **Setup** Menu.

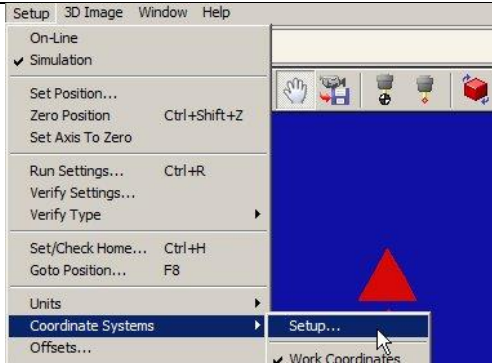

The Setup Coordinate Systems window is displayed.

3. Select one of the **G54** to **G59** codes
4. Enter the coordinates for the first workpiece, and click on **Apply**.

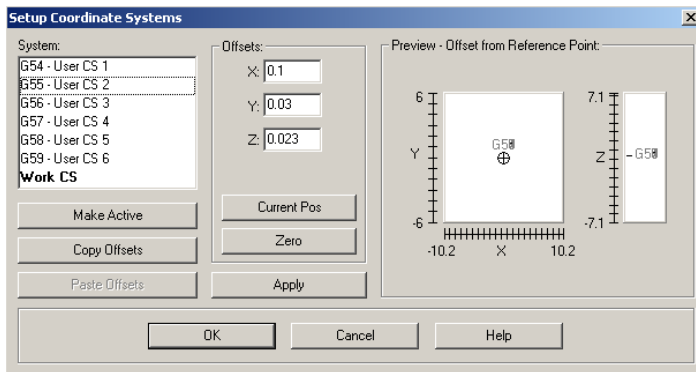

5. Repeat this procedure for as many coordinate systems as necessary by setting up a coordinate system for each point on the part that corresponds to the zero point of the shape you are milling.
6. In your program, use the Coordinate Systems group G codes to switch between coordinate system and run the subprogram that contains the NC code for the complex shape.

11.2. SETTING SPINDLE SPEEDS

Spindle speed refers to the rotational speed at which the spindle rotates the tool around its vertical axis. Spindle speed is usually defined in units of rotations per minute (RPM).

When selecting a spindle speed, the following factors must be taken into account.

Info Table: Spindle Speed Factors

Factor	Description
Tool diameter	Spindle speed is inversely proportional to tool diameter: the larger the tool, the lower the spindle speed.
Relative material hardness	Spindle speed is inversely proportional to the relative hardness of the material: the harder the material, the slower the recommended spindle speed.

Heat production	High spindle speeds may produce excess heat which can cause the workpiece to expand. If the workpiece expands, the cutting tool will rub rather than cut the material, resulting in a poor surface finish.
Material type	Some materials require higher spindle speeds to ensure a good finish.
Load on spindle motor	Heavy cuts at low speeds will make the motor run hotter than lighter cuts at higher speeds. The selected feed rate and depth of cut should not cause the spindle motor to greatly lose speed or cause the tool to chatter against the workpiece.

11.3. SETTING FEED RATE AND DEPTH OF CUT

Feed rate (also known as feed), and depth of cut (also known as cut) are central terms in NC milling.

Milling involves removing material from the top surface or a side face of a workpiece. This is accomplished by advancing the cutting tool into the workpiece by an appropriate amount (depth of cut).

The depth of cut is the vertical distance between the surface of the workpiece and the depth to which the cutting tool enters the workpiece.

The feed rate is the speed at which the tool moves across the workpiece.

These concepts are illustrated in this image.

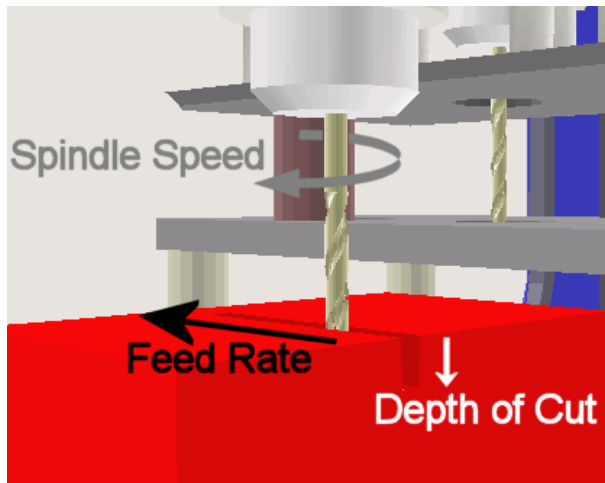

When selecting a feed rate and depth of cut, the factors listed in the table below must be taken into account. You should consult your machinist’s handbook for selecting a feed rate based on spindle speed and material type. Experience and experimentation will enable you to establish feed rates best suited to particular applications.

Info Table: Feed Rate and Depth of Cut Factors	
Factor	Description
Spindle speed	The feed rate and depth of cut you choose must be suitable for the spindle speed chosen.
Material used	Material properties may dictate maximum and minimum feed rates and depths of cut. Surface finishes may suffer if machining parameters are not set appropriately for the

	material.
Lubrication type	Some lubricants can allow for higher feed rates and deeper depths of cut than others.
Cutting tool type	Some cutting tools are capable of making deeper cuts and maintaining faster feed rates than others.
Machine capabilities	Excessive depth of cut and high feed rates place greater strain on the spindle than allowable.

11.4. SELECTING LUBRICANTS AND COOLANTS

Lubricants remove heat from the tool and workpiece and are often used when high production rates are required or when cutting very hard materials, such as stainless steel. A mixture of one part soluble oil to six parts water may be used on steel to assist in producing a smoother finish and to reduce tool chatter. Aluminum and aluminum alloys may require the use of paraffin, oil or kerosene to prevent chips from welding to the tool's cutting edge. Brass and cast iron are always machined dry.

When lubrication is necessary, small amounts of water-soluble cutting fluids are recommended for use on the ProMill milling center. Lubricants should be wiped from the machine after use, as some petroleum-based fluids may damage the electrical wiring insulation and other components.

Short runs of parts on Delrin or aluminium, such as would be performed in a school or college laboratory, do not require the use of coolant.



Take Note

The ProMill 8000 milling center is designed for flood cooling. A cooling accessory is available. Contact your dealer or Intelitek.

11.5. TOOL TYPES

Cutting tools are usually made from hardened steel and are ground to various shapes. The clearances ground behind cutting edges are adjusted for the type of material the tool will cut and the direction the tool will be fed along the workpiece. Tools are often ground to shape by the operator to suit a particular cutting requirement.

Insufficient clearance behind the cutting edge will cause the tool to rub against the workpiece. Excessive clearance will produce a ridged or wavy finish due to the small length of tool edge in contact with the workpiece. Standard tool types are: milling tools, side tools, parting tools and boring tools. Carbide tooling has become popular in recent years. Carbide is more brittle than steel, but has a longer tool life.

The following common tool types are described in the sections that follow:

Section Contents: Tool Types		
Section	Name	Page
11.5.1	End Mills	164
11.5.2	Ball Mills	164

11.5.3	Drilling Tools	164
11.5.4	Engraving Tools	165
11.5.5	Roughing and Finishing Tools	165

11.5.1. End Mills

An end mill is a tool with two or more teeth. The most commonly used end mills have two teeth and a flat-tip. End mills are used for milling flat surfaces. The end mill is the most commonly used tool for basic mill operations and creates a cut with 90-degree angle edges.



11.5.2. Ball Mills

A ball mill is an end mill with a ball tip. The rounded tip leaves a smoother finish on a contoured surface than other types of milling tools. The angle of the edges of the cut is equal to the radius of the ball tip.



11.5.3. Drilling Tools

A drill looks like an end mill with a pointed tip. Often, after a part is machined from a solid piece of stock, there are holes that have to be drilled. By changing the tool to a drill, the drilling can take place without removing the stock from the vise.



11.5.4. Engraving Tools

An engraving tool has a single sharp cutting tip. The engraving tool is used to produce very shallow, narrow, and fine cuts into the workpiece face.

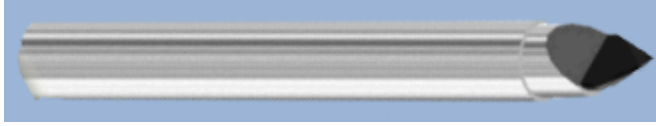

11.5.5. Roughing and Finishing Tools

Two-tooth tools are generally used for roughing operations. These tools can be moved very quickly to cover a large surface area.

A tool with a small number of teeth has relatively little contact with the workpiece in a single revolution. The material is removed from the workpiece in chunks, leaving an imperfect surface scattered with ridges. This is acceptable for roughing operations, as these imperfections will be removed during finishing.

For finishing operations, four-tooth tools are usually used. These tools remove a greater amount of material in a single revolution and provide a smooth finish. This finish comes at the expense of speed. The cutting speed must be reduced as the number of tool sides grows, to compensate for the additional heat generated during cutting.

11.6. SHARPENING THE TOOLS

Cutting tools will dull over time and need to be sharpened or replaced. Sharpened tools will have a smaller diameter so be sure to measure them and adjust the tool offsets accordingly.

12. Automation Integration

This section provides information and instructions required to integrate the ProMill 8000 within a flexible manufacturing system (FMS).

Section Contents: Automation Integration		
Section	Name	Page
12.1	Integration Instructions	166
12.2	CNC Programming for Robotic Communication	169
12.3	Sample Robot - CNC Communication Sequence	171
12.4	Sample Robotic - CNC Integration Programs	179

12.1. INTEGRATION INSTRUCTIONS

In order to be integrated into an FMS the ProMill 8000 must be able to work with machine related automation functions like an automated shield and an automated clamping device. It must also be able to communicate with a robot for the loading and unloading sequence and be able to run a G Code by command from an external control device, such as a robot program, device driver or other control entity.

This section provides instructions on how to integrate the ProMill 8000 with various other components.

Section Contents: Integration Instructions		
Section	Name	Page
12.1.1	Integrating with an Automated Shield (Pneumatic)	166
12.1.2	Integrating with an Automated Clamping Device (Pneumatic)	167
12.1.3	Interfacing with a Robot or other FMS Entity	169

12.1.1. Integrating with an Automated Shield (Pneumatic)



Take Note

Detailed installation instructions are provided with each optional accessory purchased.

The automated shield must be closed during machine operation to protect the operator. The shield is shown in its closed position in the photograph below (left). The shield must be opened to allow access for an automated loading device.

Sensors on the pneumatic piston send signals indicating its current open/closed status to the machine through an input port.

The machine sends open/close commands to the shield through an output port.

The I/O ports are located at the right side of the machine, as shown in the photograph below (right).



The automatic shield opener, in closed position

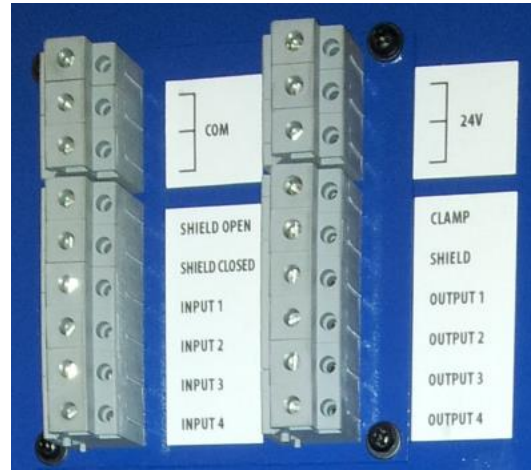

The I/ ports located at the right side of the machine

Wiring guidelines are presented in the diagram and table below.

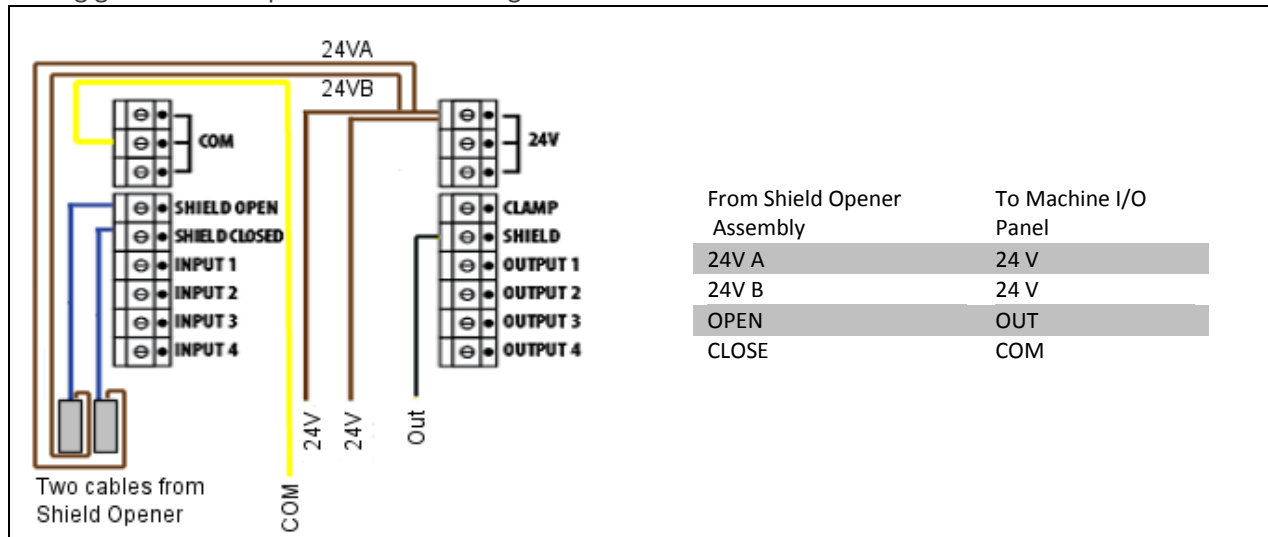

12.1.2. Integrating with an Automated Clamping Device (Pneumatic)



Take Note

Detailed installation instructions are provided with each optional accessory purchased.

The automated clamping device, shown in the photograph below (left), closes and holds the part securely during the machining process. The device opens to allow an automated loading device to load a new workpiece or remove a finished part.

The pneumatic pressure regulator system, shown in the photograph below (right), is mounted on the spindle motor access door on the right side of the machine as shown. This system regulates the air sent to the pneumatic vise forcing it to clamp onto the work piece.

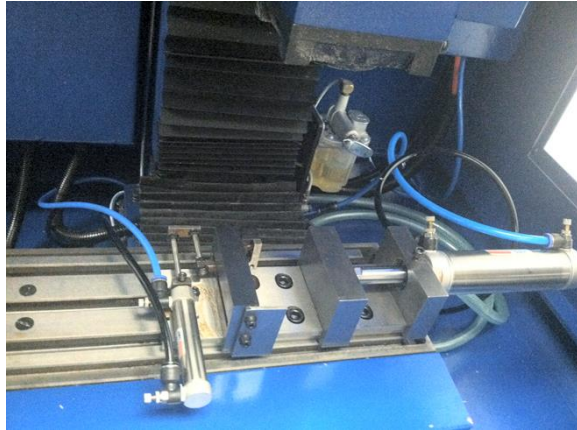

The dual-axis vise



The pneumatic pressure regulator

The machine sends open/close commands to the automated clamping device through an output port. The I/O ports are located at the right side of the machine.

Wiring guidelines are presented in the diagram and table below.

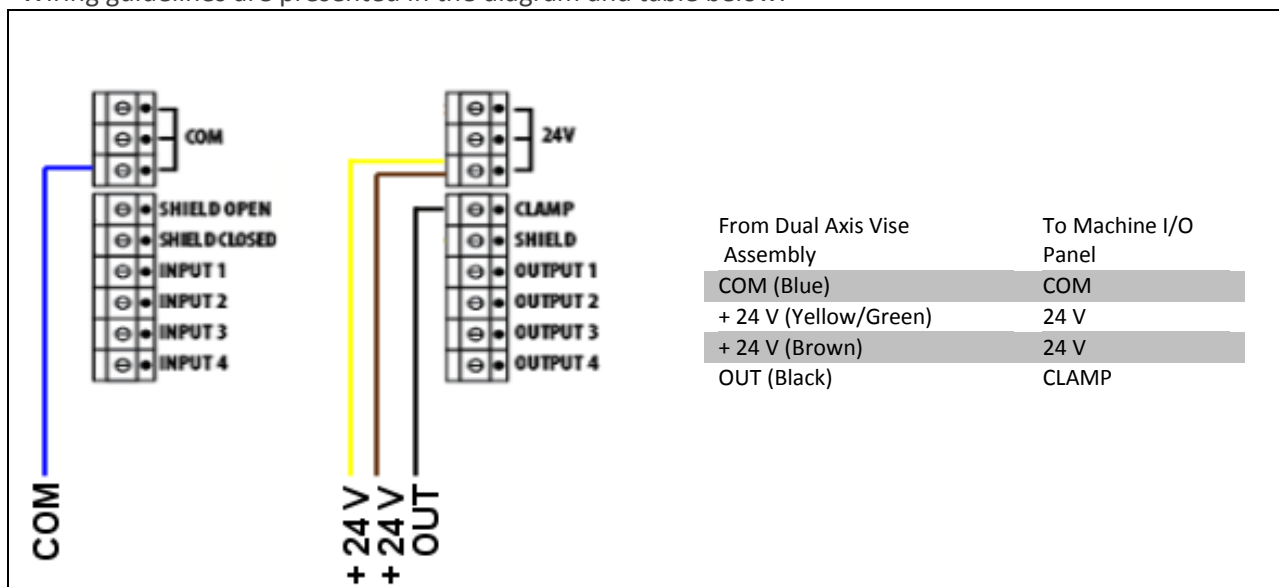

12.1.3. Interfacing with a Robot or other FMS Entity

The ProMill 8000 machining center has a simple interface for integration in an FMS cell. Such integration facilitates, for example, automated part loading and unloading between milling operations.

Most vertical articulated robots on the market can be integrated with Intelitek CNC machines.

Specific G Codes, called CHAIN TO FILE and CHAIN TO COM G Codes, allow the ProMill 8000 to receive string information. An external control device, such as a robot or device driver, can run any CNC program via this interface. The ProMill 8000 in turn notifies the external control device that the requested CNC program has been completed, via a machine output. Unlike for the machine automation devices, such as an automated shield or clamping device, the “handshake” output from the CNC machine to an external control device is wired via a relay to separate the electrical circuits of the CNC machine and the external controller.

Follow the procedure below to set up the wiring for output activation.

Procedure: Wiring for Output Activation	
1.	Wire the 24V outlet on the CNC machine’s I/O interface to the A1 leg of the relay, including a flyback diode for protection against spikes.
2.	Wire the A2 leg to the desired output on the CNC machine.
3.	When the selected output changes to ON, it will connect the 24V output to COM, thus energizing the relay.

12.2. CNC PROGRAMMING FOR ROBOTIC COMMUNICATION

This section provides information on writing CNC programs for use in an FMS.

Section Contents: CNC Programming for Robotic Communication		
Section	Name	Page
12.2.1	NC Codes for Robotic Communication	169
12.2.2	G Code Programming for Input Signals	170

12.2.1. NC Codes for Robotic Communication

The table below lists the NC codes used for robotic communication.

Info Table: NC Codes for Robotic Communication		
Code	Function	
G25	Wait for High signal	See 12.2.2 G Code Programming for Input Signals, pg 170.
G26	Wait for Low signal	
M25	Transmit High signal	

M26	Transmit Low signal
H#	Specifies the input or output number. The default is H1. The H code is used in conjunction with the Wait and Transmit codes.
Example - Input	G25H3 This code tells the CNC machine to wait until the state at input #3 goes High. Assuming the robot's initial output state is Low, if this line of code is placed at the beginning of the program, the CNC machine waits until input #3 goes High, then executes the next line of code.
Example - Output	M25H1 This code tells the CNC machine to output a High signal through output #1.

12.2.2. G Code Programming for Input Signals

Both the G25 and G26 codes pause program operation until a signal change in the specified direction is registered at the specified input. This is summarized in the table below.

Info Table: G Code Programming for Input Signals			
Code	Function	If the signal is initially	Program will continue after signal
G25	Wait for High signal	Low	changes to High
		High	changes to Low and then back to High
G26	Wait for Low signal	Low	changes to High and then back to Low
		High	changes to Low



Product Care

If the CNC machine does not respond to the robot as you have programmed it to, check that you have wired the robot to the interface correctly and that the robot's initial output state was not changed to High while connecting the robot.



Take Note

In most cases the G commands can be omitted by using a VB script to send commands from the robot to the CNC machine (for example, to open the door, open the clamping device, etc.)

M commands used to send signals from the CNC machine to the robot cannot be replaced by VB script.

12.3. SAMPLE ROBOT - CNC COMMUNICATION SEQUENCE

This section presents a sample communication sequence between a robot and a ProMill 8000 machining center, and includes sample programs.



Take Note

You may need to customize the samples for your specific CNC machine configuration.

This sample is based on a configuration that uses one CNC output Chain to File option. One could alternatively create a working interface based on one CNC output and one CNC input, using the G and M codes presented previously and corresponding sequences in the robot program.

This sample shows a typical sequence with a robot run by the SCORBASE programming language from Intelitek, with the robot defined as the master and the CNC as the slave. The machine is waiting in standby by running a program that monitors the communication channel (either a RS232 port or a file). The robot uses program code and script to send commands to the machine and monitors the machine's status via an input.

Step 1

The CNC program (START.NC) sets the CNC output so that the robot's input will be ON when START.NC is running.

START.NC (Sample)

```
;-----
; First program to run
;-----
M25 H11 ;USER OUT#1 ON
M20;CHAIN TO PROGRAM
CHAIN_FILE O:\project_name\WS3\MILL\CHAIN_FILE.TXT
```

Step 2

The robot program uses a script file similar to the script below to send commands to the CNC machine.

CHAINL.VBS (Sample)

```
' File: CHAIN.VBS   Date: 03-10-2013
Set objArgs = WScript.Arguments
NameOfFile = objArgs(0)
'WScript.Echo NameOfFile
writeFile NameOfFile
Sub WriteFile(NcProgram)
    Const FileDirectory = "O:\project_name\WS3\MILL\"
    Const ForReading = 1, ForWriting = 2, ForAppending = 3
    Const TristateUseDefault = -2, TristateTrue = -1, TristateFalse = 0
    Dim fs, f, ts, s, TempfileName
```

```

Set fs = CreateObject("Scripting.FileSystemObject")
TempFileName = FileDirectory + "chain_file.$$$"
FileName = FileDirectory + "chain_file.txt"
fs.CreateTextFile TempFileName      'Create a file
Set f = fs.GetFile(TempFileName)
Set ts = f.OpenAsTextStream(ForWriting, TristateUseDefault)
ts.Write FileDirectory      'write into the file
ts.Write NcProgram          'write into the file
ts.Close ' close the file
fs.Copyfile TempFileName,FileName
fs.deletefile TempFileName
End Sub

Sub PLACE()
  WriteFile("PLACE.NC")
End Sub

Sub OVICE()
  WriteFile("OVICE.NC")
End Sub

Sub CVICE()
  WriteFile("CVICE.NC")
End Sub

Sub ODOOR()
  WriteFile("ODOOR.NC")
End Sub

Sub CDOOR()
  WriteFile("CDOOR.NC")
End Sub

Sub SendFile(CNCProgNumber)
  WriteFile(CNCProgNumber & ".nc")
End Sub

```

Step 3

The robot checks the input signal received from the CNC machine. If the machine signals that it is idle, the robot will start the loading procedure. By this time the robot will already have picked one part from a local storage device. First the robot sends a command to the CNC machine to bring the vice in loading position.

If Input 1 Off Call Subroutine PM8000 NOT READY

Call Subroutine PLACE VICE IN LOADING POSITION

Remark: *****

Set Subroutine PLACE VICE IN LOADING POSITION

Call Subroutine SCRIPT.PLACE

Call Subroutine SYNCHRONIZE_WITH_PM8000

Return from Subroutine

Remark: *****

Step 4

The program name is transferred to the CNC control via the script file and the machine executes the task.

PLACE.NC (Sample)

```
M26 H11 ;USER OUT#1 OFF
G00 X-160 Y-20 Z160
G04F1;MAKE SURE OUTPUT IS SEEN
M20;CHAIN TO PROGRAM
START.NC
```

Step 5

The robot monitors the CNC's input signal. The robot sends a command to the CNC to open the door if the machine signals that it is idle.

If Input 1 Off Call Subroutine PM8000 NOT READY

Call Subroutine OPEN DOOR

Remark: *****

Set Subroutine OPEN DOOR

Call Subroutine SCRIPT.ODOOR

Call Subroutine SYNCHRONIZE_WITH_PM8000

Return from Subroutine

Remark: *****

Step 6

The program name is transferred to the CNC control via the script file and the machine executes the task.

ODOOR.NC (Sample)

```
M26 H11 ;USER OUT#1 OFF
M25 H102 ;OPEN DOOR
G04F2;MAKE SURE OUTPUT IS SEEN
G25 H132; Wait door open
M20;CHAIN TO PROGRAM
START.NC
```

Step 7

The robot monitors the CNC's input signal. The robot opens the clamping device if the machine signals that it is idle.

```
If Input 1 Off Call Subroutine PM8000 NOT READY
Call Subroutine OPEN VICE
Remark: *****
Set Subroutine OPEN VICE
Call Subroutine SCRIPT. VICE
Call Subroutine SYNCHRONIZE_WITH_PM8000
Return from Subroutine
Remark: *****
```

Step 8

The program name is transferred to the CNC control via the script file and the machine executes the task.

OVICE.NC (Sample)

```
M26 H11 ;USER OUT#1 OFF
M26 H4;CLOSE VICE
G04F1;MAKE SURE OUTPUT IS SEEN
M20;CHAIN TO PROGRAM
START.NC
```

Step 9

The robot monitors the CNC's input signal. Once the machine signals that it is idle, the robot inserts the part into the clamping device and then closes it.

```
Go to Position SCRIPT.P3 Speed 50 (%)
Go to Position SCRIPT.P2 Speed 50 (%)
Go Linear to Position SCRIPT.P1 Speed 30 (%)
If Input 1 Off Call Subroutine PM8000 NOT READY
Call Subroutine CLOSE VICE
Remark: *****
Set Subroutine CLOSE VICE
Call Subroutine SCRIPT. CVICE
Call Subroutine SYNCHRONIZE_WITH_PM8000
Return from Subroutine
Remark: *****
```

Step 10

The program name is transferred to the CNC control via the script file and the machine executes the task.

CVICE.NC (Sample)

M26 H11 ;USER OUT#1 OFF
 M25 H4;CLOSE VICE
 G04F1;MAKE SURE OUTPUT IS SEEN
 M20;CHAIN TO PROGRAM
 START.NC

Step 11

The robot monitors the CNC's input signal. Once the machine signals that it is idle, the robot exits the machine and closes the door.

Open Gripper
 Go Linear to Position SCRIPT.P2 Speed 30 (%)
 If Input 1 Off Call Subroutine PM8000 NOT READY
 Go to Position SCRIPT.P3 Speed 50 (%)
 Go to Position SCRIPT.P4 Speed 50 (%)
 If Input 1 Off Call Subroutine PM8000 NOT READY
 Call Subroutine CLOSE DOOR

Step 12

The program name is transferred to the CNC control via the script file and the machine executes the task.

CDOOR.NC (Sample)

M26 H11 ;USER OUT#1 OFF
 M26 H102 ;CLOSE DOOR
 G04F2;MAKE SURE OUTPUT IS SEEN
 G25 H131; Wait door closed
 M20;CHAIN TO PROGRAM
 START.NC

Step 13

Depending on the system environment, the manufacturing CNC code can be activated via an external control program (i.e. device driver) or directly from the robot program. In both cases the robot controller will monitor the CNC machine status and will wait until the CNC program is finished. The monitoring is done via an input interrupt to allow the robot to perform other tasks while waiting. The interrupt is defined at the start of the program and is enabled or disabled as required in the program.

Remark: *****
 Set Subroutine INITC
 Load script file: PCPLC3.VBS
 Disable Input Interrupt 1
 On Input Interrupt 1 On Run Subroutine PM8000_CYCLE_FINISHED
 Return from Subroutine
 Remark: *****

SMILY.NC (Sample)

M26H11 ; Put idle signal off

```
G0 X0 Y0 Z100
,*****
Between these two lines the actual manufacturing code is written
,*****
G0 X0 Y25 Z20
G0 Z50
M5
M20;CHAIN TO PROGRAM
START.NC
```

Step 14

Once the input interrupt that monitors the CNC machine is activated, the robot will start the unloading sequence as soon as the robot is available. The sequence starts with the robot checking the input signal coming from the CNC machine. If the machine signals that it is idle the robot will start the unloading procedure.

```
If Input 1 Off Call Subroutine PM8000 NOT READY
Call Subroutine PLACE VICE IN LOADING POSITION
Remark: *****
Set Subroutine PLACE VICE IN LOADING POSITION
Call Subroutine SCRIPT.PLACE
Call Subroutine SYNCHRONIZE_WITH_PM8000
Return from Subroutine
Remark: *****
```

Step 15

The program name is transferred to the CNC control via the script file and the machine executes the task.

PLACE.NC (Sample)

```
M26 H11 ;USER OUT#1 OFF
G00 X-160 Y-20 Z160
G04F1;MAKE SURE OUTPUT IS SEEN
M20;CHAIN TO PROGRAM
START.NC
```

Step 16

The robot monitors the CNC's input signal. The robot opens the door if the machine signals that it is idle.

```
If Input 1 Off Call Subroutine PM8000 NOT READY
Call Subroutine OPEN DOOR
Remark: *****
Set Subroutine OPEN DOOR
Call Subroutine SCRIPT.ODOOR
```

Call Subroutine SYNCHRONIZE_WITH_PM8000

Return from Subroutine

Remark: *****

Step 17

The program name is transferred to the CNC control via the script file and the machine executes the task.

ODOOR.NC (Sample)

```
M26 H11 ;USER OUT#1 OFF
M25 H102 ;OPEN DOOR
G04F2;MAKE SURE OUTPUT IS SEEN
G25 H132; Wait door open
M20;CHAIN TO PROGRAM
START.NC
```

Step 18

The robot enters the machine, reaches the part and closes its gripper. It monitors the CNC's input signal, and opens the clamping device if the machine signals that it is idle.

```
Go to Position SCRIPT.P3 Speed 50 (%)
Go to Position SCRIPT.P2 Speed 50 (%)
Open Gripper
Go Linear to Position SCRIPT.P1 Speed 30 (%)
Close Gripper
If Input 1 Off Call Subroutine PM8000 NOT READY
Call Subroutine OPEN VICE
Remark: *****
Set Subroutine OPEN VICE
Call Subroutine SCRIPT. OVICE
Call Subroutine SYNCHRONIZE_WITH_PM8000
Return from Subroutine
Remark: *****
```

Step 19

The program name is transferred to the CNC control via the script file and the machine executes the task.

OVICE.NC (Sample)

```
M26 H11 ;USER OUT#1 OFF
M26 H4;CLOSE VICE
G04F1;MAKE SURE OUTPUT IS SEEN
M20;CHAIN TO PROGRAM
START.NC
```

Step 20

The robot monitors the CNC's input signal. Once the machine signals that it is idle the robot extracts the part from the VICE and closes the VICE.

```
Go to Position SCRIPT.P2 Speed 50 (%)
Go to Position SCRIPT.P3 Speed 50 (%)
If Input 1 Off Call Subroutine PM8000 NOT READY
Call Subroutine CLOSE VICE
Remark: *****
Set Subroutine CLOSE VICE
Call Subroutine SCRIPT. CVICE
Call Subroutine SYNCHRONIZE_WITH_PM8000
Return from Subroutine
Remark: *****
```

Step 21

The program name is transferred to the CNC control via the script file and the machine executes the task.

CVICE.NC (Sample)

```
M26 H11 ;USER OUT#1 OFF
M25 H4;CLOSE VICE
G04F1;MAKE SURE OUTPUT IS SEEN
M20;CHAIN TO PROGRAM
START.NC
```

Step 22

The robot monitors the CNC's input signal. Once the machine signals that it is idle, the robot exits the machine and then closes the door.

```
Open Gripper
Go Linear to Position SCRIPT.P2 Speed 30 (%)
If Input 1 Off Call Subroutine PM8000 NOT READY
Go to Position SCRIPT.P3 Speed 50 (%)
Go to Position SCRIPT.P4 Speed 50 (%)
If Input 1 Off Call Subroutine PM8000 NOT READY
Call Subroutine CLOSE DOOR
```

Step 23

The program name is transferred to the CNC control via the script file and the machine executes the task.

CDOOR.NC (Sample)

```
M26 H11 ;USER OUT#1 OFF
M26 H102 ;CLOSE DOOR
```

G04F2;MAKE SURE OUTPUT IS SEEN

G25 H131; Wait door closed

M20;CHAIN TO PROGRAM

START.NC

Step 24

The robot transfers the part to the next process or to its target storage.

12.4. SAMPLE ROBOTIC - CNC INTEGRATION PROGRAMS

This section presents a selection of sample programs used for integrating a CNC machining center in an FMS.

Section Contents: Sample Robotic – CNC Integration Programs		
Section	Name	Page
12.4.1	Sample NC Programs	179
12.4.2	Sample Device Driver Script File	181
12.4.3	Sample SCORBASE Programs	182
12.4.4	Sample VB Script File	188

12.4.1. Sample NC Programs

START.NC

```
;-----
; First program to run
;-----
M25 H11 ;USER OUT#1 ON
M20;CHAIN TO PROGRAM
CHAIN_FILE O:\project_name\WS3\MILL\CHAIN_FILE.TXT
```

PLACE.NC

```
M26 H11 ;USER OUT#1 OFF
G00 X-160 Y-20 Z160
G04F1;MAKE SURE OUTPUT IS SEEN
M20;CHAIN TO PROGRAM
START.NC
```

ODOOR.NC

```
M26 H11 ;USER OUT#1 OFF
M25 H102 ;OPEN DOOR
G04F2;MAKE SURE OUTPUT IS SEEN
G25 H132; Wait door open
```

M20;CHAIN TO PROGRAM
START.NC

CDOOR.NC

M26 H11 ;USER OUT#1 OFF
M26 H102 ;CLOSE DOOR
G04F2;MAKE SURE OUTPUT IS SEEN
G25 H131; Wait door closed
M20;CHAIN TO PROGRAM
START.NC

OVICE.NC

M26 H11 ;USER OUT#1 OFF
M26 H4;CLOSE VICE
G04F1;MAKE SURE OUTPUT IS SEEN
M20;CHAIN TO PROGRAM
START.NC

CVICE.NC

M26 H11 ;USER OUT#1 OFF
M25 H4;CLOSE VICE
G04F1;MAKE SURE OUTPUT IS SEEN
M20;CHAIN TO PROGRAM
START.NC

SMILY.NC

M26H11 ; Put idle signal off
G0 X0 Y0 Z100
,*****
g00 x45 y0 z10
m03 s2000
g00 x45 y3 z2
g01 x45 y3 z-2 f200
g02 x45 y3 i45 j25
g01 x45 y3 z2
g00 x60 y25
g01 x60 y25 z-2
g02 x30 y25 i45 j25
g01 x30 y25 z2

```

g00 x45 y20
g01 x45 y20 z-2
g01 x45 y27
g01 x45 y27 z2
g00 x52 y35
g01 x52 y35 z-2
g01 x52 y35 z2
g00 x38 y35
g01 x38 y35 z-2
g01 x38 y35 z2
g00 x0 y0 z10
,*****
G0 X0 Y25 Z20
G0 Z50
M5
M20
START.NC

```

12.4.2. Sample Device Driver Script File

Shown below is a sample device driver script file for use in OpenCIM or FMS.

REQUEST	ACTION	RETURN
OPERATE0	DRAW(---PM8000 OPERATE ---)	
	sendmsg(2581)	
	DRAW(-- OPERATING ---)	
	MSWINDOWS(cscript O:\project_name\WS3\MILL\CHAIN.VBS P1)	
	SENDSTR(V1,RUN WAIT_CYCLE_END_PM8000)	
	WAITSTR(V3,18000000)	
	SENDMSG(2582)	
	SENDMSG(2580)	
	DRAW(---END---)	
END		
ABORT	ABORT()	
END		
INITC		
END		
OPEN DOOR	DRAW(---OPEN PM8000 DOOR ---)	
	MSWINDOWS(cscript O:\ project_name \WS3\MILL\CHAIN.VBS ODOOR)	
END		
CLOSE DOOR	DRAW(---CLOSE PM8000 DOOR ---)	
	MSWINDOWS(cscript O:\ project_name \WS3\MILL\CHAIN.VBS CDOOR)	
END		

OPEN VICE	DRAW(---OPEN PM8000 VICE ---)	
	MSWINDOWS(cscript O:\ project_name \WS3\MILL\CHAIN.VBS OVICE)	
END		
CLOSE VICE	DRAW(---CLOSE PM8000 CHUCK ---)	
	MSWINDOWS(cscript O:\ project_name \WS3\MILL\CHAIN.VBS CVICE)	
END		
PLACE	DRAW(---PLACE PM8000 VICE---)	
	MSWINDOWS(cscript O:\ project_name \WS3\MILL\CHAIN.VBS VICE)	
END		

12.4.3. Sample SCORBASE Programs

Shown below is a sample SCORBASE program for use in a typical FMS station in an OpenCIM/FMS environment.

```

Remark: $ Beginning of automatically generated code
Call Subroutine $PICK_AND_PLACE_0,31,1,1,3,101
Set Subroutine $PICK_AND_PLACE_0,31,1,1,3,101
Set Variable TASK_ID = 300014
Set Variable PART_ID = 0
Set Variable SOURCE_DEVICE_ID = 31
Set Variable SOURCE_DEVICE_INDEX = 1
Set Variable TARGET_DEVICE_ID = 1
Set Variable TARGET_DEVICE_INDEX = 3
Set Variable PICK_AND_PLACE_NOTE = 101
Call Subroutine AUTOEXEC
Call Subroutine GET031
Call Subroutine PUT001
Return from Subroutine
Remark: $ End of automatically generated code

Remark: *****
Set Subroutine INITC
Load script file: PCPLC3.VBS
Disable Input Interrupt 1
On Input Interrupt 1 On Run Subroutine PM8000_CYCLE_FINISHED
Return from Subroutine

Remark: *****
Set Subroutine AUTOEXEC
Set Variable SCRIPT.PART_ID = PART_ID
Set Variable SCRIPT.SOURCE_DEVICE_ID = SOURCE_DEVICE_ID
Set Variable SCRIPT.SOURCE_DEVICE_INDEX = SOURCE_DEVICE_INDEX
Set Variable SCRIPT.TARGET_DEVICE_ID = TARGET_DEVICE_ID
Set Variable SCRIPT.TARGET_DEVICE_INDEX = TARGET_DEVICE_INDEX

```

Set Variable SCRIPT.PICK_AND_PLACE_NOTE = PICK_AND_PLACE_NOTE

Return from Subroutine

Remark: *****

Set Subroutine GET001

Print to Screen: GET TEMPLATE FROM CONVEYOR (CNV1)

Call Subroutine SCRIPT.GET_FROM_CNV1

Print to Screen: P1,P2,P3,PB1: 'SCRIPT.P1', 'SCRIPT.P2','SCRIPT.P3','SCRIPT.PB1'

Go to Position SCRIPT.P3 Fast

Go to Position SCRIPT.PB1 Fast

Open Gripper

Go to Position SCRIPT.P2 Fast

Go Linear to Position SCRIPT.P1 Speed 30 (%)

Close Gripper

Go to Position SCRIPT.P2 Fast

Send Message \$Start to MANAGER ID=TASK_ID

Return from Subroutine

Remark: *****

Set Subroutine PUT001

Print to Screen: PUT TEMPLATE ON CONVEYOR (CNV1)

Call Subroutine SCRIPT.PUT_TO_CNV1

Print to Screen: P1,P2,P3,PB1: 'SCRIPT.P1', 'SCRIPT.P2','SCRIPT.P3','SCRIPT.PB1'

Go to Position SCRIPT.P3 Fast

Go to Position SCRIPT.PB1 Fast

Go to Position SCRIPT.P2 Fast

Go Linear to Position SCRIPT.P1 Speed 50 (%)

Open Gripper

Go Linear to Position SCRIPT.P2 Speed 30 (%)

Go to Position SCRIPT.P3 Fast

Send Message \$Finish to MANAGER ID=TASK_ID

Send Message \$End to MANAGER ID=TASK_ID

Return from Subroutine

Remark: *****

Set Subroutine GET031

Print to Screen: GET FROM BUFFER3

Call Subroutine SCRIPT.GET_FROM_BUFFER3

Print to Screen: P1,P2,P3,PB1: 'SCRIPT.P1', 'SCRIPT.P2','SCRIPT.P3','SCRIPT.PB1'

Go to Position SCRIPT.P3 Fast

Go to Position SCRIPT.PB1 Fast

Open Gripper

Go to Position SCRIPT.P2 Fast

Go Linear to Position SCRIPT.P1 Speed 30 (%)

```

Close Gripper
Go Linear to Position SCRIPT.P2 Fast
Send Message $Start to MANAGER ID=TASK_ID
Return from Subroutine
Remark: *****
Set Subroutine PUT031
Print to Screen: PUT TO BUFFER3
Call Subroutine SCRIPT.PUT_TO_BUFFER3
Print to Screen: P1,P2,P3,PB1: 'SCRIPT.P1', 'SCRIPT.P2','SCRIPT.P3','SCRIPT.PB1'
Go to Position SCRIPT.P3 Fast
Go to Position SCRIPT.PB1 Fast
Go to Position SCRIPT.P2 Fast
Go Linear to Position SCRIPT.P1 Speed 30 (%)
Open Gripper
Go Linear to Position SCRIPT.P2 Fast
Send Message $Finish to MANAGER ID=TASK_ID
Send Message $End to MANAGER ID=TASK_ID
Return from Subroutine
Remark: *****
Set Subroutine GET032
Print to Screen: GET FROM MILL (PM8000)
Call Subroutine SCRIPT.GET_FROM_MILL1
Print to Screen: P1,P2,P3,P4,PB1: 'SCRIPT.P1', 'SCRIPT.P2','SCRIPT.P3','SCRIPT.P4','SCRIPT.PB1'
Go to Position SCRIPT.P4 Speed 50 (%)
Go to Position SCRIPT.PB1 Fast
If Input 1 Off Call Subroutine PM8000 NOT READY
Call Subroutine PLACE VICE IN LOADING POSITION
If Input 1 Off Call Subroutine PM8000 NOT READY
Call Subroutine OPEN DOOR
Go to Position SCRIPT.P3 Speed 50 (%)
Open Gripper
Go to Position SCRIPT.P2 Speed 50 (%)
Go Linear to Position SCRIPT.P1 Speed 30 (%)
Close Gripper
If Input 1 Off Call Subroutine PM8000 NOT READY
Call Subroutine OPEN VICE
Go Linear to Position SCRIPT.P2 Speed 30 (%)
Go to Position SCRIPT.P3 Speed 50 (%)
Go to Position SCRIPT.P4 Speed 50 (%)
If Input 1 Off Call Subroutine PM8000 NOT READY
Call Subroutine CLOSE DOOR

```

Send Message \$Start to MANAGER ID=TASK_ID

Return from Subroutine

Remark: *****

Set Subroutine PUT032

Print to Screen: PUT_TO_MILL (PM8000)

Call Subroutine SCRIPT.PUT_TO_MILL1

Print to Screen: P1,P2,P3,P4,PB1: 'SCRIPT.P1', 'SCRIPT.P2','SCRIPT.P3','SCRIPT.P4','SCRIPT.PB1'

Go to Position SCRIPT.P4 Speed 50 (%)

Go to Position SCRIPT.PB1 Fast

If Input 1 Off Call Subroutine PM8000 NOT READY

Call Subroutine PLACE VICE IN LOADING POSITION

If Input 1 Off Call Subroutine PM8000 NOT READY

Call Subroutine OPEN DOOR

If Input 1 Off Call Subroutine PM8000 NOT READY

Call Subroutine OPEN VICE

Go to Position SCRIPT.P3 Speed 50 (%)

Go to Position SCRIPT.P2 Speed 50 (%)

Go Linear to Position SCRIPT.P1 Speed 30 (%)

Open Gripper

Go Linear to Position SCRIPT.P2 Speed 30 (%)

If Input 1 Off Call Subroutine PM8000 NOT READY

Call Subroutine CLOSE VICE

Go to Position SCRIPT.P3 Speed 50 (%)

Go to Position SCRIPT.P4 Speed 50 (%)

If Input 1 Off Call Subroutine PM8000 NOT READY

Call Subroutine CLOSE DOOR

Send Message \$Finish to MANAGER ID=TASK_ID

Send Message \$End to MANAGER ID=TASK_ID

Return from Subroutine

Remark: *****

Set Subroutine GET033

Print to Screen: GET PART FROM FEEDER (FDR1)

Call Subroutine SCRIPT.GET_FROM_FDR1

Print to Screen: P1,P2,P3,PB1: 'SCRIPT.P1', 'SCRIPT.P2','SCRIPT.P3','SCRIPT.PB1'

Go to Position SCRIPT.PB1 Fast

Go to Position SCRIPT.P4 Speed 50 (%)

Wait Until Digital Input 2 is ON

Go to Position SCRIPT.P2 Speed 50 (%)

Open Gripper

Go Linear to Position SCRIPT.P1 Speed 30 (%)

Close Gripper

Go Linear to Position SCRIPT.P3 Speed 50 (%)

Go to Position SCRIPT.P4 Speed 50 (%)

Send Message \$Start to MANAGER ID=TASK_ID

Return from Subroutine

Remark: *****

Set Subroutine PUT033

Print to Screen: PUT TO FEEDER

Print to Screen: SHOULD NEVER HAPPEN

Return from Subroutine

Remark: *****

Set Subroutine GET034

Print to Screen: GET FROM RACK2

Call Subroutine SCRIPT.GET_FROM_RACK2

Print to Screen: P1,P2,P3,PB1: 'SCRIPT.P1', 'SCRIPT.P2','SCRIPT.P3','SCRIPT.PB1'

Go to Position SCRIPT.P3 Speed 50 (%)

Go to Position SCRIPT.PB1 Fast

Go to Position SCRIPT.P2 Speed 50 (%)

Open Gripper

Go Linear to Position SCRIPT.P1 Speed 30 (%)

Close Gripper

Go Linear to Position SCRIPT.P2 Speed 50 (%)

Go to Position SCRIPT.P3 Speed 50 (%)

Send Message \$Finish to MANAGER ID=TASK_ID

Send Message \$End to MANAGER ID=TASK_ID

Return from Subroutine

Remark: *****

Set Subroutine PUT034

Print to Screen: PUT TO RACK2

Call Subroutine SCRIPT.PUT_TO_RACK2

Print to Screen: P1,P2,P3,PB1: 'SCRIPT.P1', 'SCRIPT.P2','SCRIPT.P3','SCRIPT.PB1'

Go to Position SCRIPT.P3 Speed 50 (%)

Go to Position SCRIPT.PB1 Fast

Go to Position SCRIPT.P2 Speed 50 (%)

Go Linear to Position SCRIPT.P1 Speed 30 (%)

Open Gripper

Go Linear to Position SCRIPT.P2 Speed 50 (%)

Go to Position SCRIPT.P3 Speed 50 (%)

Send Message \$Finish to MANAGER ID=TASK_ID

Send Message \$End to MANAGER ID=TASK_ID

Return from Subroutine

Remark: *****

```
Set Subroutine SYNCHRONIZE_WITH_PM8000
Print to Screen: Synchronizing with PM8000 for Loading/Unloading
PM8000_IDLE_OFF:
Wait Until Digital Input 1 is OFF
Wait 1 (10ths of seconds)
PM8000_IDLE_ON:
Wait Until Digital Input 1 is ON
Wait 1 (10ths of seconds)
PM8000_SIGNAL_ON:
Return from Subroutine
Remark: *****
Set Subroutine WAIT_CYCLE_END_PM8000
Wait 10 (10ths of seconds)
Print to Screen: WAIT_CYCLE_END_PM8000
Enable Input Interrupt 1
Return from Subroutine
Remark: *****
Set Subroutine PM8000_CYCLE_FINISHED
Print to Screen: PM8000 is ready
Disable Input Interrupt 1
Print to Screen: Send message ENDMILL to Dev. 32
Send Message ENDMILL to Device Driver ID=32
Return from Subroutine
Remark: *****
Set Subroutine OPEN DOOR
Call Subroutine SCRIPT.ODOOR
Call Subroutine SYNCHRONIZE_WITH_PM8000
Return from Subroutine
Remark: *****
Set Subroutine CLOSE DOOR
Call Subroutine SCRIPT.CDOOR
Call Subroutine SYNCHRONIZE_WITH_PM8000
Return from Subroutine
Remark: *****
Set Subroutine OPEN VICE
Call Subroutine SCRIPT.OVICE
Call Subroutine SYNCHRONIZE_WITH_PM8000
Return from Subroutine
Remark: *****
Set Subroutine CLOSE VICE
Call Subroutine SCRIPT.CVICE
```

Call Subroutine SYNCHRONIZE_WITH_PM8000

Return from Subroutine

Remark: *****

Set Subroutine PLACE VICE IN LOADING POSITION

Call Subroutine SCRIPT.PLACE

Call Subroutine SYNCHRONIZE_WITH_PM8000

Return from Subroutine

Remark: *****

Set Subroutine PM8000 NOT READY

Print to Screen & Log: PM8000 NOT READY!!! CHECK AND RESTART PRODUCTION!!!

Print to Screen & Log: OR CONTINUE PRODUCTION FROM CURRENT LOCATION.

Return from Subroutine

Remark: *****

Set Subroutine SHUTDOWN

Print to Screen: MOVING TO SHUTDOWN POSITION (Robot&LSB)

Go to Position 499 Speed 50 (%)

Close Gripper

Return from Subroutine

Remark: *****

12.4.4. Sample VB Script File

CHAINL.VBS

' File: CHAIN.VBS Date: 03-10-2013

Set objArgs = WScript.Arguments

NameOfFile = objArgs(0)

'WScript.Echo NameOfFile

writeFile NameOfFile

Sub WriteFile(NcProgram)

Const FileDirectory = "O:\ project_name \WS3\MILL\"

Const ForReading = 1, ForWriting = 2, ForAppending = 3

Const TristateUseDefault = -2, TristateTrue = -1, TristateFalse = 0

Dim fs, f, ts, s, TempfileName

Set fs = CreateObject("Scripting.FileSystemObject")

TempFileName = FileDirectory + "chain_file.\$\$\$"

FileName = FileDirectory + "chain_file.txt"

fs.CreateTextFile TempFileName 'Create a file

Set f = fs.GetFile(TempFileName)

Set ts = f.OpenAsTextStream(ForWriting, TristateUseDefault)

ts.Write FileDirectory 'write into the file

ts.Write NcProgram 'write into the file

ts.Close ' close the file

```
fs.Copyfile TempFileName,FileName  
fs.deletefile TempFileName  
End Sub
```

```
Sub CLEAR()  
WriteFile("CLEAR.NC")  
End Sub
```

```
Sub OVICE()  
WriteFile("OVICE.NC")  
End Sub
```

```
Sub CVICE()  
WriteFile("CVICE.NC")  
End Sub
```

```
Sub ODOOR()  
WriteFile("ODOOR.NC")  
End Sub
```

```
Sub CDOOR()  
WriteFile("CDOOR.NC")  
End Sub
```

```
Sub SendFile(CNCProgNumber)  
WriteFile(CNCProgNumber & ".nc")  
End Sub
```